

PRECISION SAWING TOOLS

STATUS: 01.10.2023



Contents (1/2)

Bimetal Band Saw Blades **4–54**

MARATHON® M42	4	PROFLEX® PREMIUM SW M42	29
SELEKTA® GS M42	9	SKALAR® M42	32
PROFLEX® M42	12	SKALAR® PREMIUM M42	35
MARATHON® X3000®	17	SKALAR® X3000®	38
SELEKTA® GS X3000®	20	PROFLEX® SW M42	41
PROFLEX® PREMIUM M42	23	SELEKTA® GS PREMIUM M42	45
MARATHON® SW M42	26	PRIMAR® M42	49

Carbide Band Saw Blades **55–117**

FUTURA®	55	FUTURA® NE	89
FUTURA® PREMIUM	59	ECODUR®	93
FUTURA® VA	63	TCTYRE®	97
FUTURA® PREMIUM VA	66	TCT®	100
FUTURA® 718	69	DUROSET® PREMIUM	103
DUROSET®	73	TAURUS®	106
DUROSET® NE	76	TAURUS® PREMIUM	109
FUTURA® SN	79	FUTURA® NE RS	112
PROFIDUR®	82	FUTURA® PREMIUM SN	115
ARION® FG	85		

Coated Band Saw Blades **118–157**

CUBOGRIT® S	118	CUBOGRIT® U	122
-------------	-----	-------------	-----

Contents (2/2)

DIAGRIT® K	126	DIAGRIT® U VA	144
DIAGRIT® S	130	TCGRIT® K	147
DIAGRIT® U	134	TCGRIT® U	150
DIAGRIT® K VA	138	CUBOGRIT® K	153
DIAGRIT® S VA	141		

 Precision Circular Saw Blades		158–166	
KREOS®	158	MIRUS®	163

MARATHON[®] M42

The All-Rounder for Small and Large Cross Sections



- ▲ Product level 2
- 🪚 Hook tooth
- Solid materials
- ↕ Band width 13 x 0.65 - 80 x 1.6mm
Band width 1/2 x 0.025 - 3-1/8 x 0.063 Inch

Product Information

MARATHON[®] M42 – The All-Rounder for Small and Large Cross Sections

The MARATHON[®] M42 is the epitome of the economical band saw blade and stands for a broad application spectrum with consistently high quality.

The bimetal band saw blade for service-oriented customers is optimized for more complex performance and support requirements in the sawing process, such as those required for industrial applications.

The high quality features of MARATHON[®] M42 are now even more flexible in applications thanks to the expansion of the product line and are thus available for small cross-sections up to large solid materials.

The superfinishing of the band saw blade and the sharp cutting edges increase the blade-life and improve the quality of the cut. The fine band surface protects the machine's guides and increases fatigue strength.

Application Range

Application

- industrial applications

- medium-sized to large workpieces
- All metals up to 1000 N/mm² tensile strength
- Solid material
- Single, layer and bundle cutting
- Mixed operation

Advantages

- Long blade-life and high productivity due to excellent product characteristics
- Less frequent blade changes due to broad application spectrum
- Low noise levels due to highly smooth and quiet running
- Lower material allowances required due to straight cuts/li>
- Reduced post-processing due to finer cutting surface
- Significant costs per cut savings

Features

- M42 cutting edge
- rake angle: positive (hooktooth)
- Constant or variable tooth pitch with standard setting

- High precision in straightness and planeness of the strip

Technical Data (1/2)

Dimensions		Tooth pitch in ZpZ					
Width x thickness		variable					
mm	Inch	5-8	4-6	3-4	2-3	1.4-2	1-1.4
13 x 0.65	1/2 x 0.025						
13 x 0.90	1/2 x 0.035						
20 x 0.90	3/4 x 0.035						
20 x 1.10	3/4 x 0.042						
27 x 0.90	1-1/16 x 0.035	K	K	K	K		
34 x 1.10	1-3/8 x 0.042	K	K	K	K	K	
41 x 1.10	1-5/8 x 0.042		K	K	K	K	
41 x 1.30	1-5/8 x 0.050	K	K	K	K	K	
54 x 1.30	2-1/8 x 0.050		K	K	K	K	
54 x 1.60	2-1/8 x 0.063		K	K	K	K	K
67 x 1.60	2-5/8 x 0.063		K	K	K	K	K
80 x 1.60	3-1/8 x 0.063				K	K	K
Contact length	[mm]	30-60	50-100	80-170	150-300	250-550	500-1000
	[Inch]	1.2-2.4	2-3.9	3.1-6.7	5.9-11.8	9.8-21.6	19.7-39.4

K = Hook tooth

*Optimised superfinish:

With immediate effect, this dimension is now also converted to the new inline production. As a result, the saw band gains a high quality in the form of a glossy, smooth surface. The fine band surface protects the band guides of the machine and increases the fatigue strength.

Technical Data (2/2)

Dimensions		Tooth pitch in ZpZ				
Width x thickness		variable	constant			
mm	Inch	0.75-1.25	6	4	3	1.25
13 x 0.65	1/2 x 0.025		K*	K*		
13 x 0.90	1/2 x 0.035		K*	K*	K*	
20 x 0.90	3/4 x 0.035		K	K	K	
20 x 1.10	3/4 x 0.042				K	
27 x 0.90	1-1/16 x 0.035					
34 x 1.10	1-3/8 x 0.042					K
41 x 1.10	1-5/8 x 0.042					
41 x 1.30	1-5/8 x 0.050					
54 x 1.30	2-1/8 x 0.050					
54 x 1.60	2-1/8 x 0.063					
67 x 1.60	2-5/8 x 0.063	K				
80 x 1.60	3-1/8 x 0.063	K				
Contact length	[mm]	700-1400	50-80	80-120	120-200	300-800
	[Inch]	27.6-55.1	2-3.1	3.1-4.7	4.7-7.9	11.8-31.5

K = Hook tooth

*Optimised superfinish:

With immediate effect, this dimension is now also converted to the new inline production. As a result, the saw band gains a high quality in the form of a glossy, smooth surface. The fine band surface protects the band guides of the machine and increases the fatigue strength.

Materials Overview



- Case-hardening steels, spring steels and ball-bearing steels
- Rust-proof and acid-resistant steels (ferretic)
- Nitrided steel, high-speed steel and tool steel
- Construction, deep-drawn and machining steels
- Carbon steels, and quenched and tempered steels
- Cast iron
- Aluminium / aluminium alloys
- Non-ferrous metals

SELEKTA[®] GS M42

High performance with Superfinishing



⊕ Product level 3

🪚 Hook tooth

● Solid materials

Band width 27 x 0.9 - 80 x 1.6mm

↕ Band width 1-1/16 x 0.035 - 3-1/8 x 0.063
Inch

Product Information



SELEKTA[®] GS M42 – High performance with Superfinishing

Applications

- Metals up to 1000 N/mm² tensile strength
- High cutting rate with small and large solid material

Advantages

- Low finishing due to perfect surface quality
- Low material allowance by exact gating
- Short cutting time by high performance

Features

- Patented performance and surface teeth
- M42 cutting edge with extra positive rake angle

Technical Data

Dimensions		Tooth pitch in ZpZ				
Width x thickness						
mm	Inch	4-6	3-4	2-3	1.4-2	1-1.4
27 x 0.90	1-1/16 x 0.035	K	K	K		
34 x 1.10	1-3/8 x 0.042	K	K	K		
41 x 0.90	1-5/8 x 0.035			K		
41 x 1.30	1-5/8 x 0.050	K	K	K	K	
54 x 1.30	2-1/8 x 0.050		K	K	K	
54 x 1.60	2-1/8 x 0.063		K	K	K	K
67 x 1.60	2-5/8 x 0.063				K*	K*
80 x 1.60	3-1/8 x 0.063				K*	K*
Contact length	[mm]	50-100	80-170	150-300	250-550	500-1000
	[Inch]	2-3.9	3.1-6.7	5.9-11.8	9.8-21.6	19.7-39.4

K = Hook tooth

*Optimised superfinish:

From now on, this dimension will be changed to the new inline production. This gives the saw band a high quality finish in the form of a shiny, smooth surface. The fine band surface protects the band guides of the machine and increases the fatigue strength. The other dimensions will be successively tightened.

Materials Overview



- Case-hardening steels, spring steels and ball-bearing steels
- Rust-proof and acid-resistant steels (ferretic)
- Nitrided steel, high-speed steel and tool steel
- Construction, deep-drawn and machining steels
- Carbon steels, and quenched and tempered steels
- Cast iron
- Aluminium / Si-alloys
- Non-ferrous metals

PROFLEX[®] M42

The perfect band saw blade for profiles



- ▲ Product level 2
- 🔍 Profile tooth
- Profiles
- ↕ Band width 13 x 0.65 - 67 x 1.6mm
Band width 1/2 x 0.025 - 2-5/8 x 0.063 Inch

Product Information



PROFLEX[®] M42 – The perfect band saw blade for profiles

With the PROFLEX[®] M42 bimetal band saw blade, WIKUS continues to sharpen its profile in the cutting of girders and profiles. PROFLEX[®] M42 is given extremely sturdy properties by both the special profile tooth and the extended connection between the cutting material and the carrier band.

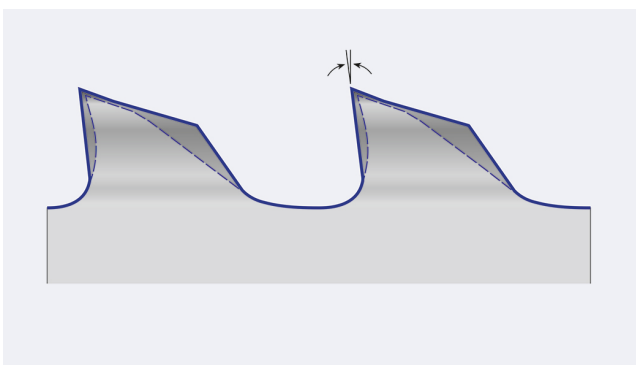

The special profile tooth features a positive cutting angle and reinforced tooth back edge. This reduces susceptibility to tooth breakage and vibration when sawing profiles.

Insensitive to mechanical stress

The high load capacity of the PROFLEX[®] M42 band saw blade results from the very stable tooth geome-

try. The innovative new production procedure with Superfinishing significantly extends the carrier band's lifetime, thus reducing the risk of bandbreakage. The optimized tooth cutting sharpness as well as a special limitation lead to an increased efficiency.

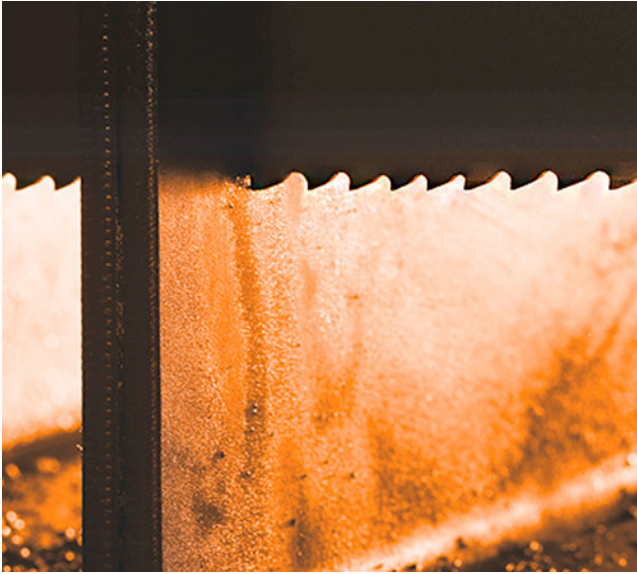

Application Range

Application

- Metal and steel profiles and carriers
- Optimal for cutting with interrupted cutting channel

Advantages

- Resistant to broken teeth due to extremely stable tooth geometry
- Low finishing due to low-burr cutting edges
- Less susceptible to vibration due to the special teeth form
- Less broken bands due to new production procedure
- Low noise emission due to variable tooth pitch and positive rake angle

Features

- Profile tooth with extremely stable tooth geometry
- variable tooth pitch
- Special limitation
- M42 tooth edge with positive rake angle

Technical Data (1/2)

Dimensions		Tooth pitch in ZpZ					
Width x thickness							
mm	Inch	14-18	12-16	10-14	8-11	7-9	5-7
13 x 0.65	1/2 x 0.025	P*		P*	P*	P*	
13 x 0.90	1/2 x 0.035			P*	P*	P*	
20 x 0.90	3/4 x 0.035		P	P	P	P	P
27 x 0.90	1-1/16 x 0.035		P	P	P	P	P
34 x 1.10	1-3/8 x 0.042				P	P	P
41 x 1.30	1-5/8 x 0.050				P	P	P
54 x 1.30	2-1/8 x 0.050						
54 x 1.60	2-1/8 x 0.063						
67 x 1.60	2-5/8 x 0.063						
Contact length	[mm]	< 5	< 10	< 15	15-30	20-50	40-70
	[Inch]	< 0.2	< 0.4	< 0.6	0.6-1.2	0.8-2	1.6-2.8

P = Profile tooth

P* = Optimised superfinish:

With immediate effect, this dimension is now also converted to the new inline production. As a result, the saw band gains a high quality in the form of a glossy, smooth surface. The fine band surface protects the band guides of the machine and increases the fatigue strength.

Technical Data (2/2)

Dimensions		Tooth pitch in ZpZ		
Width x thickness				
mm	Inch	4-6	3-4	2-3
13 x 0.65	1/2 x 0.025			
13 x 0.90	1/2 x 0.035			
20 x 0.90	3/4 x 0.035	P		
27 x 0.90	1-1/16 x 0.035	P	P	
34 x 1.10	1-3/8 x 0.042	P	P	P
41 x 1.30	1-5/8 x 0.050	P	P	P
54 x 1.30	2-1/8 x 0.050	P	P	P
54 x 1.60	2-1/8 x 0.063	P	P	P
67 x 1.60	2-5/8 x 0.063			P
Contact length	[mm]	50-90	80-160	150-310
	[Inch]	2-3.5	3.1-6.3	5.9-12.2

P = Profile tooth

P* = Optimised superfinish:

With immediate effect, this dimension is now also converted to the new inline production. As a result, the saw band gains a high quality in the form of a glossy, smooth surface. The fine band surface protects the band guides of the machine and increases the fatigue strength.

Materials Overview



- Case-hardening steels, spring steels and ball-bearing steels
- Rust-proof and acid-resistant steels (ferretic)
- Nitrided steel, high-speed steel and tool steel
- Construction, deep-drawn and machining steels
- Carbon steels, and quenched and tempered steels
- Cast iron
- Aluminium / aluminium alloys
- Non-ferrous metals

MARATHON® X3000®

— The special band saw blade for high-strength and difficult-to-cut materials

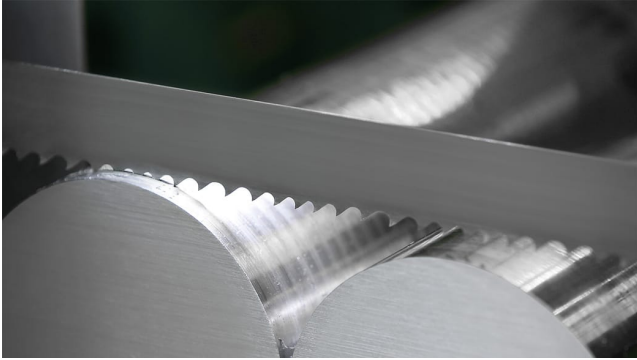

⊕ Product level 2

🔪 Hook tooth

● Profiles + Solid materials

Band width 27 x 0.9 - 67 x 1.6mm

↕ Band width 1-1/16 x 0.035 - 2-5/8 x 0.063
Inch

Product Information

MARATHON® X3000® — The special band saw blade for high-strength and difficult-to-cut materials

For the sawing of high-alloyed, difficult-to-machine materials as well as tempered steels (over 1000 N/mm² tensile strength), WIKUS has developed the cutting material X3000®.

X3000® is characterized by its high hardness and excellent toughness. This combination of material properties results in a particularly good cutting edge stability with MARATHON® X3000®.

In combination with the carrier band made of alloyed tempering steel, the MARATHON® X3000® bimetal band saw blade achieves outstanding continuous operation properties.

Application Range

Application

- High-alloy austenitic materials
- Steels from 1000 N/mm² tensile strength
- Scaled forging ingots

Advantages

- Good blade-life despite difficult-to-machine materials
- Low material loss due to good cutting section flatness
- High wear resistance with hard materials
- Cost savings due to less frequent blade changes
- Excellent continuous operation properties
- Excellent cutting quality due to highly smooth and quiet running

Features

- Tooth edge made of the cutting material X3000® with positive rake angle
- High cutting edge stability and high wear resistance
- Variable tooth pitch and standard set

Technical Data

Dimensions		Tooth pitch in ZpZ				
Width x thickness						
mm	Inch	5-8	4-6	3-4	2-3	1.4-2
27 x 0.90	1-1/16 x 0.035	K	K	K	K	
34 x 1.10	1-3/8 x 0.042		K	K	K	
41 x 1.30	1-5/8 x 0.050		K	K	K	
54 x 1.60	2-1/8 x 0.063		K	K	K	K
67 x 1.60	2-5/8 x 0.063			K	K	K
Contact length	[mm]	30-60	50-100	80-170	150-300	250-550
	[Inch]	1.2-2.4	2-3.9	3.1-6.7	5.9-11.8	9.8-21.6

K = Hook tooth

Materials Overview



- Rust-proof and acid-resistant steels (ferretic)
- Nickel-based alloys
- Titanium / titanium alloys
- Tempered steels (over 1000 N/mm² / 32 HRC)
- Duplex and heat-resistant steels
- Aluminium bronzes

SELEKTA[®] GS X3000[®]

High performance with Superfinishing for materials difficult to cut

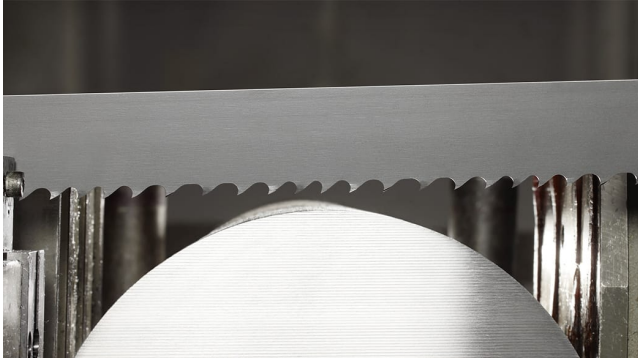

▲ Product level 3

🪚 Hook tooth

● Solid materials

Band width 27 x 0.9 - 80 x 1.6mm

↕ Band width 1-1/16 x 0.035 - 3-1/8 x 0.063
Inch

Product Information

SELEKTA[®] GS X3000[®] – High performance with Superfinishing for materials difficult to cut

Applications

- Rust- and acid-resistant steels and alloys (austenitic)
- Duplex and heat-resistant steels
- For outstanding demands in surface quality and gating

Advantages

- Excellent productivity by short cutting times
- Fewer blade changes due to increased blade-life
- Perfect surfaces for low finishing

Features

- Tooth edge made of the cutting material X3000[®] with positive rake angle
- High cutting edge stability and high wear resistance
- Patented performance and surface teeth

Technical Data

Dimensions		Tooth pitch in ZpZ					
Width x thickness							
mm	Inch	4-6	3-4	2-3	1.4-2	1-1.4	0.7-1
27 x 0.90	1-1/16 x 0.035	K	K	K			
34 x 1.10	1-3/8 x 0.042	K	K	K			
41 x 1.30	1-5/8 x 0.050	K	K	K	K		
54 x 1.30	2-1/8 x 0.050			K	K		
54 x 1.60	2-1/8 x 0.063		K	K	K		
67 x 1.60	2-5/8 x 0.063			K	K	K	
80 x 1.60	3-1/8 x 0.063					K	K
Contact length	[mm]	50-100	80-170	150-300	250-550	500-1000	900-2000
	[Inch]	2-3.9	3.1-6.7	5.9-11.8	9.8-21.6	19.7-39.4	35.4-78.7

K = Hook tooth

Materials Overview



- Nickel-based alloys
- Titanium / titanium alloys
- Tempered steels (over 1000 N/mm² / 32 HRC)
- Rust-proof and acid-resistant steels (austenitic)
- Duplex and heat-resistant steels
- Aluminium bronzes

PROFLEX® PREMIUM M42

The hard material coated band saw blade for profiles

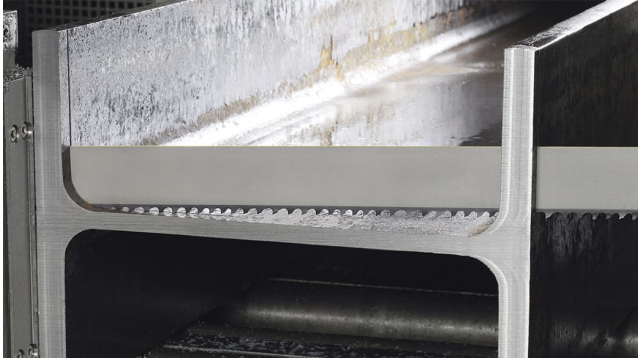

- ⊕ Product level 2
- 🔍 Profile tooth
- Profiles
- ↕ Band width 34 x 1.1 - 67 x 1.6mm
Band width 1-3/8 x 0.042 - 2-5/8 x 0.063 Inch

Product Information

PROFLEX® PREMIUM M42 – The hard material-coated band saw blade for profiles

The PROFLEX® PREMIUM M42 is equipped with a special profile tooth form, which have a positive rake angle and a reinforced tooth back. The susceptibility to broken teeth and the occurrence of vibrations are thus significantly reduced.

This special design results in particularly high tooth stability in continuous use.

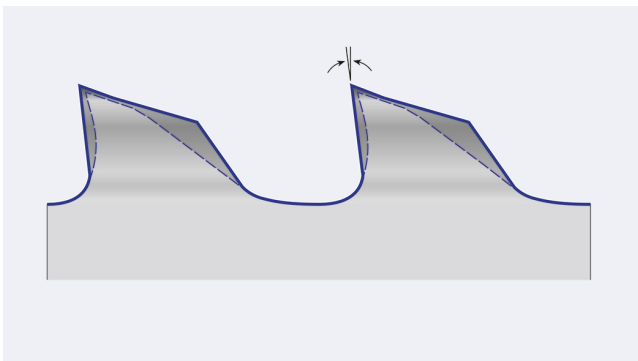

The PROFLEX® PREMIUM M42 is equipped with a special profile tooth form, which have a positive rake angle and a reinforced tooth back. The susceptibility

to broken teeth and the occurrence of vibrations are thus significantly reduced.

This special design results in particularly high tooth stability in continuous use.

Application Range

Application

- Profiles and girders in the steel construction sector and for industrial profile cuts
- Optimal for cutting with interrupted cutting channel

Advantages

- Productivity increase due to highest cutting rates
- Less frequent blade changes due to increased blade-life
- Less re-working due to low-burr cutting edges

Features

- Tooth edge and back edge with wear protection layer
- Variable tooth pitch with specific special limitation
- Extremely stable tooth geometry
- Coated M42 tooth edge with positive rake angle

Technical Data

Dimensions		Tooth pitch in ZpZ				
Width x thickness						
mm	Inch	12-16	5-7	4-6	3-4	2-3
20 x 0.90	3/4 x 0.035	P				
27 x 0.90	1-1/16 x 0.035	P				
34 x 1.10	1-3/8 x 0.042		P	P	P	
41 x 1.30	1-5/8 x 0.050				P	
54 x 1.60	2-1/8 x 0.063				P	P
67 x 1.60	2-5/8 x 0.063				P	P
Contact length	[mm]	80-160	40-70	50-100	80-160	150-300
	[Inch]	3.1-6.3	1.6-2.8	2-3.9	3.1-6.3	5.9-11.8

P = Profile tooth

Materials Overview



- Case-hardening steels, spring steels and ball-bearing steels
- Rust-proof and acid-resistant steels (ferretic)
- Nitrided steel, high-speed steel and tool steel
- Construction, deep-drawn and machining steels
- Carbon steels, and quenched and tempered steels
- Cast iron
- Aluminium / aluminium alloys
- Non-ferrous metals

MARATHON® SW M42

Special design for cutting applications with residual stress materials



- Ⓐ Product level 2
- 🔪 Hook tooth
- Solid materials and profiles
- ↕ Band width 34 x 1.1 - 67 x 1.6mm
Band width 1-5/8 x 0.050 - 2-5/8 x 0.063 Inch

Product Information

MARATHON® SW M42 – Special designs for cutting applications with residual stress material

MARATHON® SW M42 has an extra wide set that prevents jamming of the band saw blade when cutting materials with residual stress.

The bimetal band saw blade is particularly impressive for its high performance when sawing solid materials and profiles with residual stresses. The all-rounder for a wide range of applications makes sawing particularly economical.

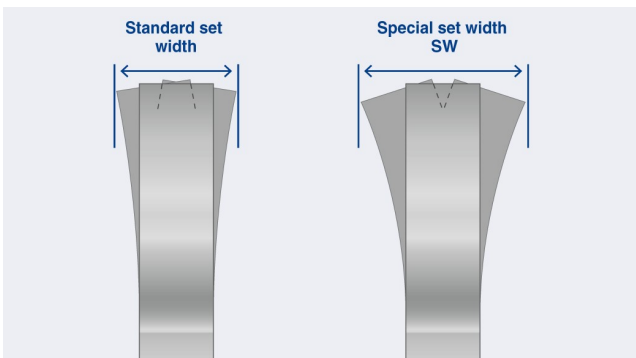

Special set width SW: The extra wide set achieves the free cut of the band saw blade so that there is more clearance to prevent jamming due to decreasing material residual stress.

Application Range

Application

- Workpieces with residual stress
- Metals up to 1000 N/mm² tensile strength

Advantages

- No jamming in the cutting channel with material residual stresses
- Cost savings due to less frequent blade changes and straight cuts
- Excellent cutting quality due to highly smooth and quiet running
- High performance
- Less post-processing due to low burr formation

Features

- Extra wide set and variable tooth pitch
- M42 tooth edge with positive rake angle
- Insensitive to jamming in the event of residual stresses in the material

Technical Data

Dimensions		Tooth pitch in ZpZ		
Width x thickness		variable		constant
mm	Inch	3-4	2-3	1.25
34 x 1.10	1-3/8 x 0.042			K
41 x 1.30	1-5/8 x 0.050	K	K	
54 x 1.60	2-1/8 x 0.063	K	K	
67 x 1.60	2-5/8 x 0.063	K	K	
Contact length	[mm]	80-170	150-300	300-800
	[Inch]	3.1-6.7	5.9-11.8	11.8-31.5

K = Hook tooth

Materials Overview



- Case-hardening steels, spring steels and ball-bearing steels
- Rust-proof and acid-resistant steels (ferretic)
- Nitrided steel, high-speed steel and tool steel
- Construction, deep-drawn and machining steels
- Carbon steels, and quenched and tempered steels
- Cast iron
- Aluminium / aluminium alloys
- Non-ferrous metals

PROFLEX[®] PREMIUM SW M42

The coated special design for residual stress materials

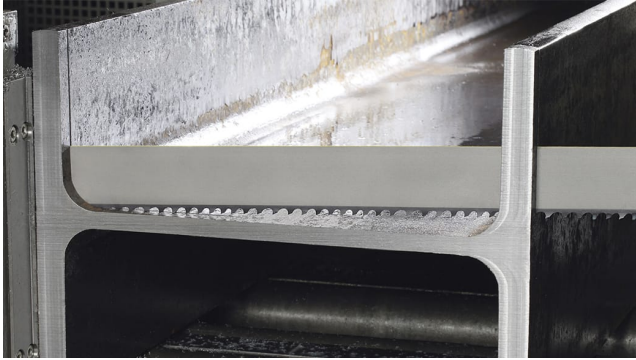

- ⊕ Product level 2
- 📐 Profile tooth
- Profiles
- ↕ Band width 41 x 1,3 - 67 x 1,6mm
Band width 1-5/8 x 0.050 - 2-5/8 x 0.063 Inch

Product Information

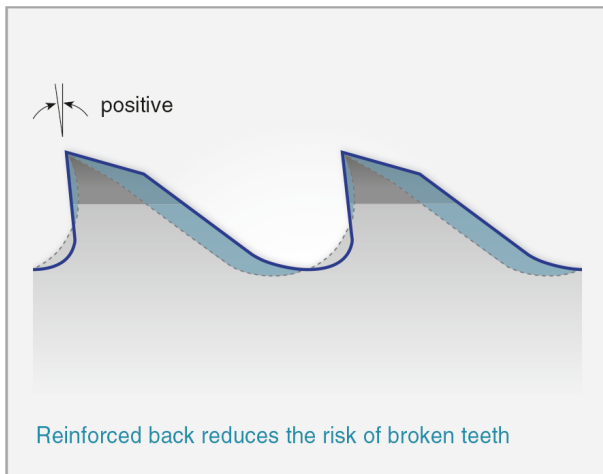

- Fewer blade changes due to increased blade-life

Features

- Tooth edge and back edge coated with wear protection
- Extra wide step set and variable tooth pitch

The coated special design for residual stress materials

Applications

- Profiles and structurals with residual stress
- For steel construction and industrial profile cuts

Advantages

- Productivity increase by high cutting rate
- No jamming in the cutting channel

Technical Data

Dimensions		Tooth pitch in ZpZ	
Width x thickness			
mm	Inch	3-4	2-3
41 x 1.30	1-5/8 x 0.050	P	P
54 x 1.60	2-1/8 x 0.063	P	P
67 x 1.60	2-5/8 x 0.063	P	P
Contact length	[mm]	80-160	150-300
	[Inch]	3.1-6.3	5.9-11.8

P = Profile tooth

Materials Overview



- Case-hardening steels, spring steels and ball-bearing steels
- Rust-proof and acid-resistant steels (ferretic)
- Nitrided steel, high-speed steel and tool steel
- Construction, deep-drawn and machining steels
- Carbon steels, and quenched and tempered steels
- Cast iron
- Aluminium / aluminium alloys
- Non-ferrous metals

SKALAR® M42

The high-performer for large cross-sections



⊕ Product level 3

🔪 Hook tooth

● Solid materials

Band width 27 x 0.9 - 80 x 1.6mm

↕ Band width 1-1/16 x 0.035 - 3-1/8 x 0.063
Inch

Product Information

SKALAR® M42 – The high-performer for large cross-sections

Sawing tools often reach their limits, especially when cutting large cross-sections. This results in very long cutting times, early deflection and an early end of blade-life. Frequent blade changes result in high tool costs and production delays.

The SKALAR® M42 bimetal band saw blade cuts with considerably reduced cutting forces due to its intelligent cutting division, thus enabling a significant increase in productivity.

Application

- Large blocks in industrial production
- Especially for mixing programs with a large material mix
- Also for difficult-to-machine non-ferrous special alloys
- All metals up to a tensile strength of 1000 N/mm² can be used

Advantages

- Extremely high cutting rates even with large cross-sections and in continuous operation
- Short cutting time, lower cutting forces
- Smooth running and straight cutting surfaces
- Wide variety of materials to be machined
- Less frequent blade changes, higher machine availability and output

Features

- High productivity and efficiency due to specially designed cutting geometry
- Ground contour with specially matched tooth pitch
- M42 cutting edge with extra positive rake angle
- Special set for optimal chip division
- Stability increase in the backing material
- Excellent chip removal at contact lengths of 2000 mm

HNote: This band saw blade is also available as **SKALAR® PREMIUM M42** with coating to further increase performance.

Technical Data

Dimensions		Tooth pitch in ZpZ					
Width x thickness							
mm	Inch	2.5-3.4	1.8-2.5	1.4-1.8	1.2-1.6	1-1.4	0.7-1
27 x 0.90	1-1/16 x 0.035	K					
34 x 1.10	1-3/8 x 0.042	K	K				
41 x 1.30	1-5/8 x 0.050	K	K	K			
54 x 1.30	2-1/8 x 0.050	K	K	K			
54 x 1.60	2-1/8 x 0.063	K	K	K	K	K	
67 x 1.60	2-5/8 x 0.063			K*	K*	K*	K*
80 x 1.60	3-1/8 x 0.063				K*	K*	K*
Contact length	[mm]	100-220	180-350	300-600	400-700	500-1000	900-2000
	[Inch]	3.9-8.7	7.1-13.8	11.8-23.6	15.7-27.6	19.7-39.4	35.4-78.7

K = Hook tooth

*Optimised superfinish:

From now on, this dimension will be changed to the new inline production. This gives the saw band a high quality finish in the form of a shiny, smooth surface. The fine band surface protects the band guides of the machine and increases the fatigue strength. The other dimensions will be successively tightened.

Materials Overview



- Case-hardening steels, spring steels and ball-bearing steels
- Rust-proof and acid-resistant steels (ferretic)
- Nitrided steel, high-speed steel and tool steel
- Construction, deep-drawn and machining steels
- Carbon steels, and quenched and tempered steels
- Cast iron
- Aluminium / aluminium alloys
- Non-ferrous metals

SKALAR® PREMIUM M42

The high-performer with extra blade-life



⊕ Product level 3

🪚 Hook tooth

● Solid materials

Band width 27 x 0.9 - 80 x 1.6mm

↕ Band width 1-1/16 x 0.035 - 3-1/8 x 0.063
Inch

Product Information

The high-performer with extra blade-life

The coated SKALAR® PREMIUM M42 band saw blade was specially developed by WIKUS for workpieces with large cross-sections. Compared to the uncoated band saw blade SKALAR® M42, it achieves even higher cutting rates with a significantly increased lifetime in continuous operation and impresses with its vibration-resistant and smooth running.

The reliable, precise operation of the SKALAR® PREMIUM M42 allows for multi-machine operation in large sawmills. Combined with the less frequent belt changes and the ability to precisely separate different material, this results in impressively high efficiency.

Application

- High cutting rate, also continuous operation in large steel mills
- All metals up to a tensile strength of 1400 N/mm² can be used

Advantages

- High productivity and output

- Extended lifetime due to additional wear protection coating
- Less frequent blade changes, higher machine availability
- Low vibration and smooth running
- Reliable and efficient multi-machine operation

Features

- Tooth edge with special coating
- Back edge coating for low friction
- Optimum chip division due to special setting
- Wide variety of materials to be machined

Technical Data

Dimensions		Tooth pitch in ZpZ					
Width x thickness							
mm	Inch	2.5-3.4	1.8-2.5	1.4-1.8	1.2-1.6	1-1.4	0.7-1
27 x 0.90	1-1/16 x 0.035	K					
34 x 1.10	1-3/8 x 0.042	K	K				
41 x 1.30	1-5/8 x 0.050	K	K				
54 x 1.30	2-1/8 x 0.050	K					
54 x 1.60	2-1/8 x 0.063	K	K	K	K		
67 x 1.60	2-5/8 x 0.063			K	K	K	
80 x 1.60	3-1/8 x 0.063				K	K	K
Contact length	[mm]	100-220	180-350	300-600	400-700	500-1000	900-2000
	[Inch]	3.9-8.7	7.1-13.8	11.8-23.6	15.7-27.6	19.7-39.4	35.4-78.7

K = Hook tooth

Materials Overview



- Case-hardening steels, spring steels and ball-bearing steels
- Rust-proof and acid-resistant steels (ferretic)
- Nitrided steel, high-speed steel and tool steel
- Construction, deep-drawn and machining steels
- Carbon steels, and quenched and tempered steels
- Cast iron
- Aluminium / aluminium alloys
- Non-ferrous metals

SKALAR® X3000®

The high-performer for high-strength materials

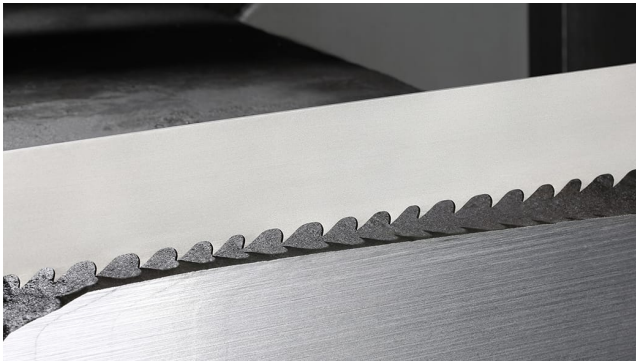

- ▲ Product level 3
- 🪚 Hook tooth
- Solid materials
- ↕ Band width 27 x 0.9 - 100 x 1.6mm
Band width 1-1/16 x 0.035 - 4 x 0.063 Inch

Product Information

SKALAR® X3000® – The high-performer for high-strength materials

The modified X3000® cutting material enables high-strength materials and special alloys to be cut precisely. This cutting material, available exclusively from WIKUS, combines even higher tooth tip hardness and wear resistance with excellent toughness compared to the M42 cutting material.

In combination with the carrier band made of alloyed tempering steel, the SKALAR® X3000® bimetal band saw blade achieves outstanding continuous operation properties.

Application

- High cutting performance with high-alloy austenitic materials
- Continuous operation on large sawmills and on large blocks
- Especially for mixing programs with a large material mix
- Also for difficult-to-machine non-ferrous special alloys

- ESU material, materials above 1000 N/mm² tensile strength

Advantages

- High productivity due to excellent cutting rates
- Lower cutting forces, smooth running, and straight cutting surfaces
- Optimal tip geometry for chip division
- Fewer blade changes due to increased blade-life

Features

- Ground contour with specially matched tooth pitch
- Tooth edge made of the cutting material X3000® with positive rake angle
- Special set for optimal chip division
- High hardness, wear resistance and toughness due to the cutting material X3000®

Technical Data

Dimensions		Tooth pitch in ZpZ					
Width x thickness							
mm	Inch	2.5-3.4	1.8-2.5	1.4-1.8	1.2-1.6	1-1.4	0.7-1
27 x 0.90	1-1/16 x 0.035	K					
34 x 1.10	1-3/8 x 0.042	K	K				
41 x 1.30	1-5/8 x 0.050	K	K	K			
54 x 1.30	2-1/8 x 0.050		K				
54 x 1.60	2-1/8 x 0.063	K	K	K	K	K	
67 x 1.60	2-5/8 x 0.063		K	K	K	K	K
80 x 1.60	3-1/8 x 0.063			K	K	K	K
100 x 1.60	4 x 0.063						K
Contact length	[mm]	100-220	180-350	300-600	400-700	500-1000	900-2000
	[Inch]	3.9-8.7	7.1-13.8	11.8-23.6	15.7-27.6	19.7-39.4	35.4-78.7

K = Hook tooth

Materials Overview



- Nickel-based alloys
- Titanium / titanium alloys
- Tempered steels (over 1000 N/mm² / 32 HRC)
- Rust-proof and acid-resistant steels (austenitic)
- Duplex and heat-resistant steels
- Aluminium bronzes

PROFLEX® SW M42

Special design for profiles made of residual stress material



- ▲ Product level 2
- 🔍 Profile tooth
- Profiles
- ↕ Band width 34 x 1.1 - 67 x 1.6mm
Band width 1-3/8 x 0.042 - 2-5/8 x 0.063 Inch

Product Information

PROFLEX® SW M42 – Special designs for profiles with residual stress material

Thermal influences or plastic deformation can cause residual stresses in semi-finished products, especially in profiles. When these tensions are released during the sawing process, jamming of a conventional band saw blade in the cutting channel often occurs.

The PROFLEX® SW M42 is the result of innovative development work by WIKUS. The extra wide special set means that profiles and girders with residual stresses can be separated without any problems. The bimetal band saw blade has impressive performance, especially in steel construction and in cutting industrial profile blanks.

The PROFLEX® SW M42 is equipped with a special profile tooth form in addition to the special SW set width, which is specially adapted to materials with residual stress.

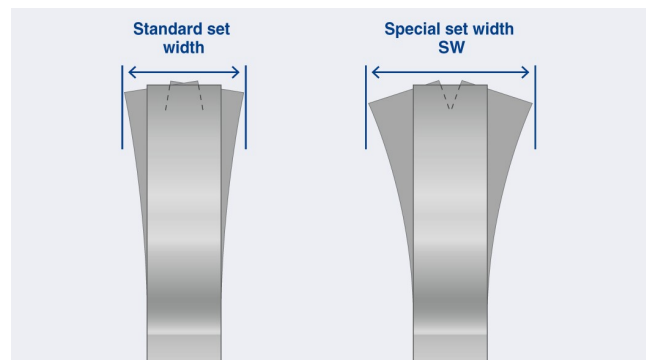

Standard set width compared to special set width SW: The extra wide set increases the free cut of the band saw blade so that there is more clearance to prevent jamming due to released material residual stress.

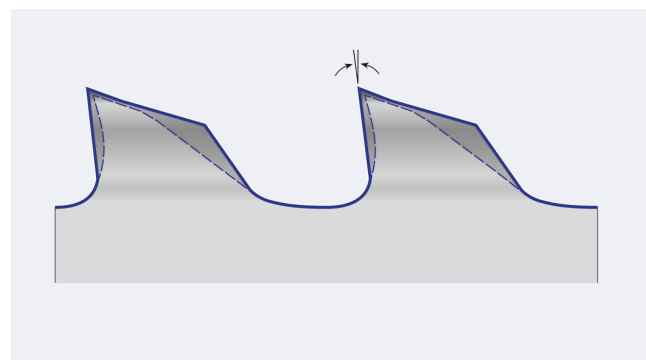

About the profile tooth form: The tooth features a positive cutting angle and a reinforced tooth back.

These factors reduce susceptibility to tooth breakage and vibration when sawing profiles.

Application

- Profiles and girders with residual stress
- For steel construction and industrial profile cuts

Advantages

- No jamming in the cutting channel
- Extra wide special limitation
- Significantly extended lifetime
- Resistant to broken teeth and bandbreakage
- Low finishing due to low-burr cutting edges
- Low noise level
- Low vibration susceptibility

Features

- Extra wide special set and variable tooth pitch
- Extremely sturdy tooth contour
- M42 tooth edge with positive rake angle

Technical Data

Dimensions		Tooth pitch in ZpZ	
Width x thickness			
mm	Inch	3-4	2-3
34 x 1.10	1-3/8 x 0.042	P	
41 x 1.30	1-5/8 x 0.050	P	P
54 x 1.30	2-1/8 x 0.050	P	
54 x 1.60	2-1/8 x 0.063	P	P
67 x 1.60	2-5/8 x 0.063	P	P
Contact length	[mm] [Inch]	80-160 3.1-6.3	150-300 5.9-11.8

P = Profile tooth

Materials Overview



- Case-hardening steels, spring steels and ball-bearing steels
- Rust-proof and acid-resistant steels (ferretic)
- Nitrided steel, high-speed steel and tool steel
- Construction, deep-drawn and machining steels
- Carbon steels, and quenched and tempered steels
- Cast iron
- Aluminium / aluminium alloys
- Non-ferrous metals

SELEKTA® GS PREMIUM M42

High performance, Superfinishing and extra blade-life

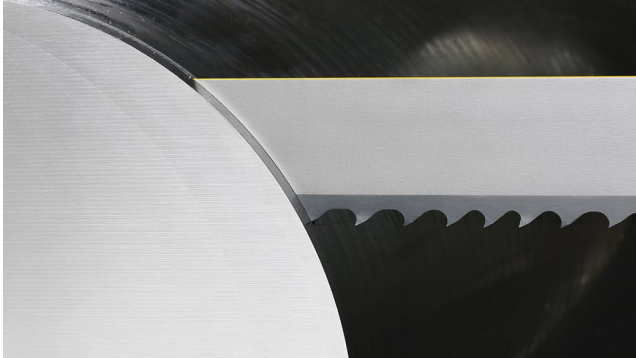

- Product level 3
- Hook tooth
- Solid materials
- Band width 34 x 1.1 - 67 x 1.6mm
Band width 1-3/8 x 0.042 - 2-5/8 x 0.063 Inch

Product Information



With the special coating in combination with the patented tooth geometry it is possible to achieve a considerable increase of blade-life compared to the uncoated version. The cutting performance is at least the same. Furthermore, the processed material is characterized by a high surface quality.

High performance, Superfinishing and extra blade-life

With the new development of the hard material-coated version of SELEKTA® GS M42 we meet high requirements on performance and lifetime.

Your advantages at a glance



high cutting performance
due to patented performance and surface teeth



high efficiency
due to an excellent blade-life



low finishing
due to perfect surface quality



lower material allowance
by exact gating



low friction
due to back edge coating



- Smooth, low vibration and very long running

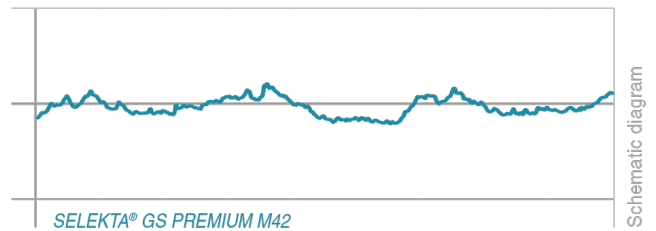
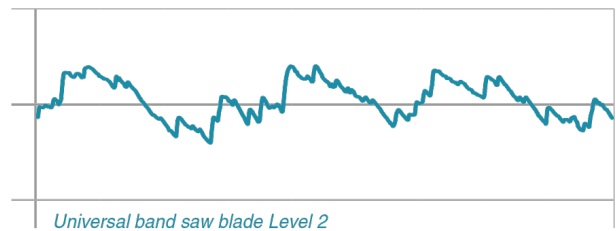
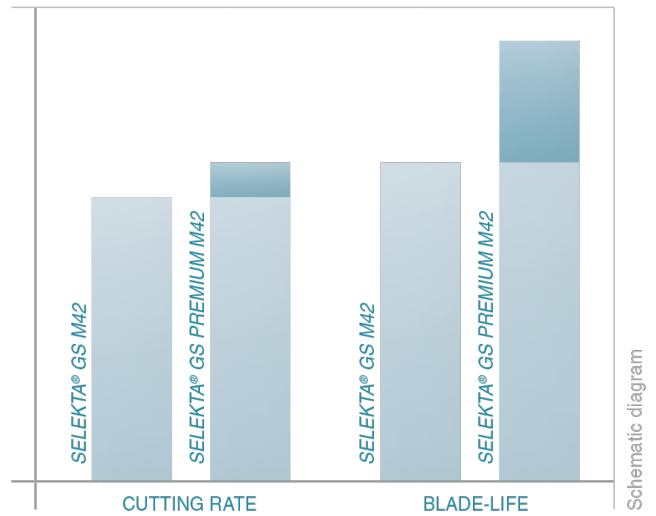

Application Range

Applications

- solid material
- metals up to 1400 N/mm² tensile strength

Features

- M42 tooth edge with special coating
- patented performance and surface teeth
- back edge coating for less friction

Technical Data

Dimensions		Tooth pitch in ZpZ			
Width x thickness					
mm	Inch	3-4	2-3	1.4-2	1-1.4
34 x 1.10	1-3/8 x 0.042	K			
41 x 1.30	1-5/8 x 0.050	K			
54 x 1.60	2-1/8 x 0.063		K	K	
67 x 1.60	2-5/8 x 0.063			K	
80 x 1.60	3-1/8 x 0.063				K
Contact length	[mm]	80-170	150-300	250-550	500-1000
	[Inch]	3.1-6.7	5.9-11.8	9.8-21.6	19.7-39.4

K = Hook tooth

Materials Overview



- Case-hardening steels, spring steels and ball-bearing steels
- Rust-proof and acid-resistant steels (ferretic)
- Nitrided steel, high-speed steel and tool steel
- Construction, deep-drawn and machining steels
- Carbon steels, and quenched and tempered steels
- Cast iron
- Aluminium / aluminium alloys
- Non-ferrous metals

PRIMAR[®] M42

The versatile option in Level-1 for small and medium-sized workpieces



- ▲ Product level 1
- 🔪 Standard or hook tooth
- Profiles + Solid materials
- ↕ Band width 6 x 0.65 - 67 x 1.6mm
Band width 1/4 x 0.025 - 2-5/8 x 0.063 Inch

Product Information

PRIMAR[®] M42 – The versatile tool for small and medium workpieces

With PRIMAR[®] M42, WIKUS is also setting standards in the bimetal level 1 segment. The innovative production process guarantees good product properties and a good blade-life - and all of this with a versatile range of applications. The cost per cut can be reduced, thanks to the high degree of process reliability.

As an economical basic solution, PRIMAR[®] M42 is aimed at cost-conscious customers and is particularly suitable for use in workshops or smaller industrial plants. At the same time, the product offers a particularly favorable price-performance ratio.

An added bonus: PRIMAR[®] M42 is available in all common dimensions and tooth pitches, allowing the band saw blade to be used in all common band saws.



Applications

- Workshop and lighter industrial applications
- Small to medium cross-sections with diameters up to 900 mm
- Small lot sizes
- Solid materials and profiles

- All metals up to 1000 N/mm² tensile strength

Advantages

- Very good price-performance ratio in the level 1 segment
- Less frequent blade changes due to a wide range of applications and thus less downtime and waiting times
- Good blade-life thanks to new production procedure
- Low noise generation due to variable tooth pitch
- Good cutting surface due to precise set of the teeth

Features

- M42 tooth edge with customised rake angle
- Rake angle: positive (hook tooth)
- Rake angle: 0° (standard tooth)
- Constant or variable tooth pitch with standard setting

Technical Data (1/3)

Dimensions		Tooth pitch in ZpZ					
Width x thickness		variable					
mm	Inch	10-14	8-12	6-10	5-8	4-6	3-4
6 x 0.65	1/4 x 0.025	S					
6 x 0.90	1/4 x 0.035	S					
10 x 0.90	3/8 x 0.035	S					
13 x 0.50	1/2 x 0.020						
13 x 0.65	1/2 x 0.025	S*	S*	S*			
20 x 0.90	3/4 x 0.035	S	S	S	S	K	
27 x 0.90	1-1/16 x 0.035	S	S	S	S	K	K
34 x 1.10	1-3/8 x 0.042		S	S	S	K	K
41 x 1.30	1-5/8 x 0.050					K	K
54 x 1.30	2-1/8 x 0.050						K
54 x 1.60	2-1/8 x 0.063						K
67 x 1.60	2-5/8 x 0.063						
Contact length	[mm]	< 20	10-30	20-50	30-60	50-100	80-170
	[Inch]	< 0.8	0.4-1.2	0.8-2	1.2-2.4	2-3.9	3.1-6.7

S = Standard tooth

K = Hook tooth

*Optimised superfinish:

With immediate effect, this dimension is now also converted to the new inline production. As a result, the saw band gains a high quality in the form of a glossy, smooth surface. The fine band surface protects the band guides of the machine and increases the fatigue strength.

**Wide set for non-ferrous metals

Technical Data (2/3)

Dimensions		Tooth pitch in ZpZ					
Width x thickness		variable			constant		
mm	Inch	2-3	1.4-2	1-1.4	18	14	6
6 x 0.65	1/4 x 0.025						
6 x 0.90	1/4 x 0.035						K
10 x 0.90	3/8 x 0.035						K
13 x 0.50	1/2 x 0.020					S*	
13 x 0.65	1/2 x 0.025				S*	S*	K*
20 x 0.90	3/4 x 0.035				S		
27 x 0.90	1-1/16 x 0.035	K			S	S	
34 x 1.10	1-3/8 x 0.042	K					
41 x 1.30	1-5/8 x 0.050	K	K				
54 x 1.30	2-1/8 x 0.050	K					
54 x 1.60	2-1/8 x 0.063	K	K	K			
67 x 1.60	2-5/8 x 0.063	K	K	K			
Contact length	[mm]	150-300	250-550	500-1000	< 10	< 15	50-80
	[Inch]	5.9-11.8	9.8-21.6	19.7-39.4	< 0.4	< 0.6	2-3.1

S = Standard tooth

K = Hook tooth

*Optimised superfinish:

With immediate effect, this dimension is now also converted to the new inline production. As a result, the saw band gains a high quality in the form of a glossy, smooth surface. The fine band surface protects the band guides of the machine and increases the fatigue strength.

**Wide set for non-ferrous metals

Technical Data (3/3)

Dimensions		Tooth pitch in ZpZ		
Width x thickness		constant		
mm	Inch	4	3	2
6 x 0.65	1/4 x 0.025			
6 x 0.90	1/4 x 0.035			
10 x 0.90	3/8 x 0.035	K		
13 x 0.50	1/2 x 0.020			
13 x 0.65	1/2 x 0.025			
20 x 0.90	3/4 x 0.035	K**	K**	
27 x 0.90	1-1/16 x 0.035	K**	K**	K**
34 x 1.10	1-3/8 x 0.042		K**	
41 x 1.30	1-5/8 x 0.050			
54 x 1.30	2-1/8 x 0.050			
54 x 1.60	2-1/8 x 0.063			
67 x 1.60	2-5/8 x 0.063			
Contact length	[mm]	80-120	120-200	200-400
	[Inch]	3.1-4.7	4.7-7.9	7.9-15.7

S = Standard tooth

K = Hook tooth

*Optimised superfinish:

With immediate effect, this dimension is now also converted to the new inline production. As a result, the saw band gains a high quality in the form of a glossy, smooth surface. The fine band surface protects the band guides of the machine and increases the fatigue strength.

**Wide set for non-ferrous metals

Materials Overview



- Case-hardening steels, spring steels and ball-bearing steels
- Rust-proof and acid-resistant steels (ferretic)
- Nitrided steel, high-speed steel and tool steel
- Construction, deep-drawn and machining steels
- Carbon steels, and quenched and tempered steels
- Cast iron
- Aluminium / aluminium alloys
- Non-ferrous metals

FUTURA[®]

The powerful best seller band saw blade



- ▲ Product level 3
- ▭ Trapezoid tooth
- Solid materials
- Band width 27 x 0.9 - 80 x 1.6mm
- ↕ Band width 1-1/16 x 0.035 - 3-1/8 x 0.063 Inch

Product Information

FUTURA[®] – The powerful best seller band saw blade

On modern band sawing machines suitable for carbide, FUTURA[®] unleashes its full potential, especially for multiple cuts on structural, case-hardened, quenched and tempered, and carbon steels.

On modern carbide-suitable band sawing machines, FUTURA[®] unleashes its full potential, especially for multiple cuts on structural, case-hardened, tempering, and carbon steels. Thanks to these benefits, the FUTURA[®] is suitable for customers with excellent standards.

Application Range

Application

- Case-hardening, tempering and tool steels
- Suitable for multiple cuts in the material mix

Advantages

- Very high cutting performance and thus productivity
- High wear resistance and thus long lifetime

- Very smooth and quiet running, low cutting forces and straight cuts

Features

- Polished trapezoid tooth with positive rake angle
- Optimized chip division

Technical Data (1/2)

Dimensions		Tooth pitch in ZpZ					
Width x thickness							
mm	Inch	3-4	2-3	1.7-2	1.4-2	1.2-1.6	1-1.4
27 x 0.90	1-1/16 x 0.035	T					
34 x 1.10	1-3/8 x 0.042	T	T				
41 x 1.30	1-5/8 x 0.050	T	T	T	T		
54 x 1.30	2-1/8 x 0.050		T		T		
54 x 1.60	2-1/8 x 0.063		T	T	T	T	T
67 x 1.60	2-5/8 x 0.063		T		T	T	T
80 x 1.60	3-1/8 x 0.063				T		T
Contact length	[mm]	80-170	150-300	250-370	290-550	400-750	500-1000
	[Inch]	3.1-6.7	5.9-11.8	9.8-14.6	11.4-21.6	15.7-29.5	19.7-39.4

T = Trapezoid tooth

Technical Data (2/2)

Dimensions		Tooth pitch in ZpZ
Width x thickness		
mm	Inch	0.85-1.15
27 x 0.90	1-1/16 x 0.035	
34 x 1.10	1-3/8 x 0.042	
41 x 1.30	1-5/8 x 0.050	
54 x 1.30	2-1/8 x 0.050	
54 x 1.60	2-1/8 x 0.063	
67 x 1.60	2-5/8 x 0.063	T
80 x 1.60	3-1/8 x 0.063	T
Contact length	[mm]	700-1400
	[Inch]	27.6-55.1

T = Trapezoid tooth

Materials Overview



- Case-hardening steels, spring steels and ball-bearing steels
- Nitrided steel, high-speed steel and tool steel
- Construction, deep-drawn and machining steels
- Carbon steels, and quenched and tempered steels
- Cast iron

FUTURA[®] PREMIUM

Increased performance due to hard coating



- ▲ Product level 3
- 📐 Trapezoid tooth
- Solid materials
- ↕ Band width 34 x 1.1 - 80 x 1.6mm
Band width 1-3/8 x 0.042 - 3-1/8 x 0.063 Inch

Product Information



FUTURA[®] PREMIUM – Increased performance due to hard coating

The aim of the technological development of FUTURA[®] PREMIUM was to enable a significant increase in the service life of the band saw blade by using a hard coating while maintaining the same high cutting parameters.

With FUTURA[®] PREMIUM, the performance spectrum in production could be increased again by approx. 20% compared to the FUTURA[®] product and at the same time, depending on the application, the blade-life could be extended by approx. 60 to 100%.

This improves productivity and blade-life. Both have a significant impact on the cost per cut and thus on the profitability of the sawing process in the plant.

Application

- Solid materials of structural, case-hardened, tempering, and carbon steels
- Industrial mass and series cutting

Advantages

- Increased performance and improved tool life due to coated tooth edges
- Extension of machine capacity in case of bottlenecks
- Increase productivity and high blade-life
- Reduction of noise emission
- Low cutting forces, reduction of cutting time and straight cuts
- Reliable even for unmanned shifts
- Significant reduction in set-up time
- Broad application spectrum achieved through fast and uninterrupted blade changes

Features

- Special hard coating for steel machining
- Additional back edge coating for lower friction

Technical Data (1/2)

Dimensions		Tooth pitch in ZpZ					
Width x thickness							
mm	Inch	3-4	2-3	1.7-2	1.4-2	1.2-1.6	1-1.4
34 x 1.10	1-3/8 x 0.042	T	T				
41 x 1.30	1-5/8 x 0.050	T	T	T	T		
54 x 1.30	2-1/8 x 0.050		T		T		
54 x 1.60	2-1/8 x 0.063		T	T	T	T	T
67 x 1.60	2-5/8 x 0.063	T	T		T	T	T
80 x 1.60	3-1/8 x 0.063				T		T
Contact length	[mm]	80-170	150-300	250-370	290-550	400-750	500-1000
	[Inch]	3.1-6.7	5.9-11.8	9.8-14.6	11.4-21.6	15.7-29.5	19.7-39.4

T = Trapezoid tooth

Technical Data (2/2)

Dimensions		Tooth pitch in ZpZ
Width x thickness		
mm	Inch	0.85-1.15
34 x 1.10	1-3/8 x 0.042	
41 x 1.30	1-5/8 x 0.050	
54 x 1.30	2-1/8 x 0.050	
54 x 1.60	2-1/8 x 0.063	
67 x 1.60	2-5/8 x 0.063	T
80 x 1.60	3-1/8 x 0.063	T
Contact length	[mm] [Inch]	700-1400 27.6-55.1

T = Trapezoid tooth

Materials Overview



- Case-hardening steels, spring steels and ball-bearing steels
- Nitrided steel, high-speed steel and tool steel
- Construction, deep-drawn and machining steels
- Carbon steels, and quenched and tempered steels
- Cast iron

FUTURA[®] VA

The high-performance bestseller for stainless steels

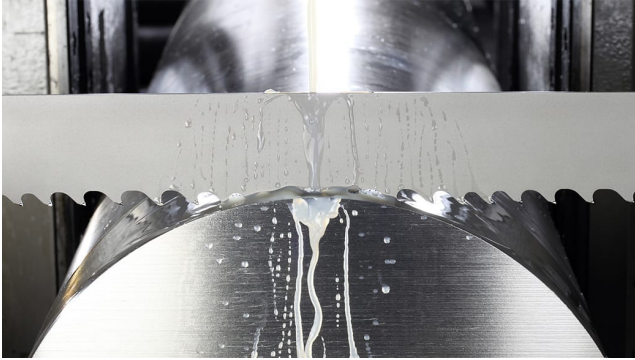

- ⊕ Product level 3
- ⚙ Trapezoid tooth
- Solid materials
- ↕ Band width 34 x 1.1 - 67 x 1.6mm
Band width 1-3/8 x 0.042 - 2-5/8 x 0.063 Inch

Product Information



The high-performance bestseller for stainless steels

Applications

- All rust- and acid-resistant steels, titanium and titanium alloys
- Serial sections

Advantages

- Optimal chip formation and perfect surface quality
- Good cutting performance for reduced cutting time
- Good blade-life reduces setup and downtime

Features

- Tooth edges made of specific carbide
- Ground trapezoid tooth with extra positive rake angle
- Optimal chip division for tough and high-strength materials

Technical Data

Dimensions		Tooth pitch in ZpZ				
Width x thickness						
mm	Inch	3-4	2-3	1.4-2	1-1.4	0.85-1.15
34 x 1.10	1-3/8 x 0.042	T	T			
41 x 1.30	1-5/8 x 0.050	T	T	T		
54 x 1.30	2-1/8 x 0.050	T	T	T		
54 x 1.60	2-1/8 x 0.063		T	T		
67 x 1.60	2-5/8 x 0.063			T	T	T
Contact length	[mm]	80-170	150-300	290-550	500-800	700-1200
	[Inch]	3.1-6.7	5.9-11.8	11.4-21.6	19.7-31.5	27.6-47.2

T = Trapezoid tooth

Materials Overview



- Rust-proof and acid-resistant steels (ferretic)
- Titanium / titanium alloys
- Tempered steels (over 1000 N/mm² / 32 HRC)
- Rust-proof and acid-resistant steels (austenitic)
- Aluminium bronzes

FUTURA[®] PREMIUM VA

The high-performance bestseller with hard material coating for stainless steels



- ⊕ Product level 3
- 📐 Trapezoid tooth
- Solid materials
- ↕ Band width 41 x 1.3 - 80 x 1.6mm
Band width 1-5/8 x 0.050 - 3-1/8 x 0.063 Inch

Product Information



The high-performance bestseller with hard material coating for stainless steels

Applications

- All rust- and acid-resistant steels, titanium and titanium alloys
- Serial sections

Advantages

- Outstanding cutting performance to bridge bottlenecks
- Guarantee for cutting larger stainless steel cross-sections
- Smooth and low vibration running

Features

- Special hard material coating for cutting stainless steels
- Extra back edge coating for lower friction

Technical Data

Dimensions		Tooth pitch in ZpZ				
Width x thickness						
mm	Inch	3-4	2-3	1.4-2	1-1.4	0.85-1.15
41 x 1.30	1-5/8 x 0.050	T	T	T		
54 x 1.60	2-1/8 x 0.063		T	T		
67 x 1.60	2-5/8 x 0.063			T		
80 x 1.60	3-1/8 x 0.063				T	T
Contact length	[mm]	80-170	150-300	290-550	500-1000	700-1400
	[Inch]	3.1-6.7	5.9-11.8	11.4-21.6	19.7-39.4	27.6-55.1

T = Trapezoid tooth

Materials Overview



- Rust-proof and acid-resistant steels (ferretic)
- Titanium / titanium alloys
- Tempered steels (over 1000 N/mm² / 32 HRC)
- Rust-proof and acid-resistant steels (austenitic)
- Aluminium bronzes

FUTURA® 718

The best band saw blade for nickel-base alloys

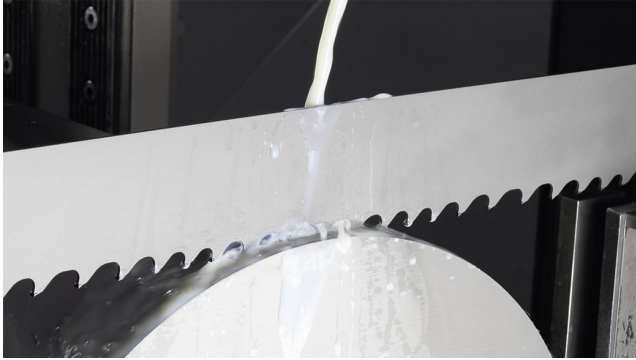

- ⊕ Product level 3
- 🔪 Trapezoid tooth
- Solid materials
- ↕ Band width 41 x 1.3 - 80 x 1.6mm
Band width 1-5/8 x 0.050 - 3-1/8 x 0.063 Inch

Product Information



FUTURA® 718 – The best band saw blade for nickel base alloys

Nickel-based alloys are indispensable, especially in the chemical industry, in engine construction, and in power generation, because they can withstand high mechanical, chemical, and thermal loads. Processing in production is correspondingly demanding.

WIKUS addresses the extremely difficult-to-cut nickel-based alloys with the FUTURA® 718 carbide band saw blade, which precisely cuts solid materials made of these superalloys.



The FUTURA® 718 carbide band saw blade offers excellent initial cutting behavior and very clean and straight cutting surfaces.

Application

- Solid material of steels, which are difficult to cut
- Nickel-based alloys
- Heat-resistant, high temperature-resistant, and duplex steels

Advantages

- Specially developed for nickel-based and similar superalloys
- Optimum chip division for tough and high-strength materials
- Reduced cutting forces for long blade-life and straight cuts
- Very good and constant cutting rate in spite of difficult cutting conditions
- Excellent initial cutting behavior results in low material loss

- Reduced finishing due to high cut surface quality

Features

- Tooth edges made of optimum carbide for high-strength tough materials
- Perfectly ground trapezoid teeth with optimum geometry
- Carrier band with special shaping for elimination of work hardening due to special mode of operation

Technical Data

Dimensions		Tooth pitch in ZpZ		
Width x thickness				
mm	Inch	2-3	1.4-2	1-1.4
41 x 1.30	1-5/8 x 0.050	T		
54 x 1.30	2-1/8 x 0.050	T	T	
54 x 1.60	2-1/8 x 0.063	T	T	
67 x 1.60	2-5/8 x 0.063	T	T	T
80 x 1.60	3-1/8 x 0.063			T
Contact length	[mm]	130-250	290-550	500-1000
	[Inch]	5.1-9.8	11.4-21.6	19.7-39.4

T = Trapezoid tooth

Materials Overview



- Nickel-based alloys
- Duplex and heat-resistant steels

DUROSET[®]

The robust all-rounder for increased performance



- ▲ Product level 2
- 📐 Hook tooth
- Solid materials
- ↕ Band width 27 x 0.9 - 100 x 1.6mm
Band width 1-1/16 x 0.035 - 4 x 0.063 Inch

Product Information

DUROSET[®] – The robust all-rounder for increased performance

The DUROSET[®] carbide band saw blade in set design stands out for its robustness and versatility both on powerful older bimetal band saw machines and on modern carbide band saw machines. This allows for performance increases of up to 50% compared to standard bimetal band saw blades.

Application

- Allsteels, suitable for forged and scaled surfaces
- Cast iron and aluminium bronze
- Also suitable for tempered materials with tensile strength greater than 1000N/mm²
- Solid material and thick-walled tubes

Advantages

- Universal use on standard band saw machines (without carbide package)
- Significant increase in productivity of the machine park

- Robust design for high wear resistance
- Low vibration and smooth running

Features

- Set tooth geometry with positive rake angle at variable tooth pitch
- Optimized sectional chip division

Technical Data

Dimensions		Tooth pitch in ZpZ					
Width x thickness		variable					constant
mm	Inch	2.5-3.4	1.8-2.5	1.4-1.8	1-1.4	0.7-1	3
27 x 0.90	1-1/16 x 0.035	K	K				K
34 x 1.10	1-3/8 x 0.042	K	K				
41 x 1.30	1-5/8 x 0.050	K	K	K			
54 x 1.30	2-1/8 x 0.050	K	K				
54 x 1.60	2-1/8 x 0.063		K	K			
67 x 1.60	2-5/8 x 0.063			K	K		
80 x 1.60	3-1/8 x 0.063				K	K	
100 x 1.60	4 x 0.063					K	
Contact length	[mm]	100-220	180-350	300-700	500-1000	900-2000	120-200
	[Inch]	3.9-8.7	7.1-13.8	11.8-27.5	19.7-39.4	35.4-78.7	4.7-7.9

K = Hook tooth

Materials Overview



- Case-hardening steels, spring steels and ball-bearing steels
- Rust-proof and acid-resistant steels (ferretic)
- Nickel-based alloys
- Nitrided steel, high-speed steel and tool steel
- Titanium / titanium alloys
- Construction, deep-drawn and machining steels
- Carbon steels, and quenched and tempered steels
- Tempered steels (over 1000 N/mm² / 32 HRC)
- Rust-proof and acid-resistant steels (austenitic)
- Duplex and heat-resistant steels
- Cast iron
- Aluminium bronzes

DUROSET[®] NE

The set special design for non-ferrous metals

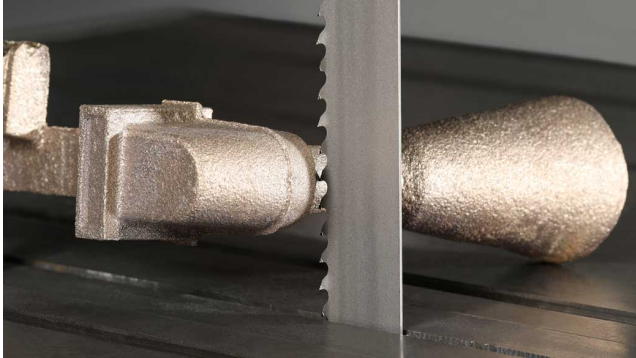

- ▲ Product level 2
- 🔪 Hook tooth
- Solid materials
- ↕ Band width 20 x 0.9 - 34 x 1.1mm
Band width 3/4 x 0.035 - 1-3/8 x 0.042 Inch

Product Information

DUROSET[®] NE – The set special design for non-ferrous metals

The carbide band saw blade was specially developed by WIKUS for foundry applications for sawing non-ferrous metals. It is particularly convincing for contour and radius cuts on feeders and casting burrs, which are carried out with a manual feed.

Of course, the band saw blade also proves itself in automatic operation. With its high blade-life, it achieves disproportionately high cutting rates even under fluctuating conditions.

Application

- Contour and radius cuts on non-ferrous metals
- Automatic and especially manual feed
- Optimal sawing tool for manual machining of castings

Advantages

- High cutting performance increases productivity

- Particularly high resistance to abrasive wear
- Very high blade-life even in fluctuating conditions

Features

- Extra wide set for contour and radius cuts in non-ferrous metals
- Tooth edge made of specific carbide with special geometry for foundries
- Polished trapezoid tooth with positive rake angle

Technical Data

Dimensions		Tooth pitch in ZpZ	
Width x thickness			
mm	Inch	3	2
20 x 0.90	3/4 x 0.035	K	
27 x 0.90	1-1/16 x 0.035	K	
34 x 1.10	1-3/8 x 0.042	K	K
Contact length	[mm]	120-200	200-400
	[Inch]	4.7-7.9	7.9-15.7

K = Hook tooth

Materials Overview



- Aluminium / aluminium alloys
- Non-ferrous metals

FUTURA[®] SN

The specialist for "hard shell and soft core"

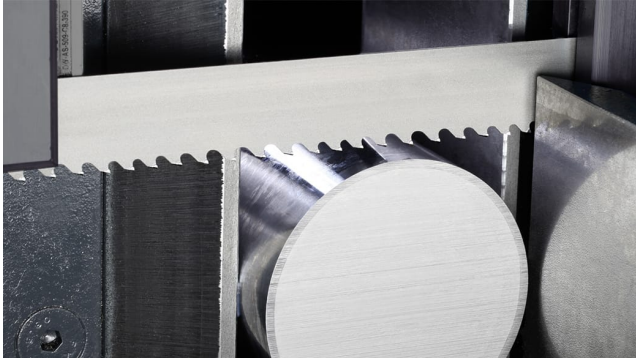

⊕ Product level S

🔍 Tooth shape TSN

● Solid materials

Band width 27 x 0.9 - 67 x 1.6mm

↕ Band width 1-1/16 x 0.035 - 2-5/8 x 0.063
Inch

Product Information



The specialist for "hard shell and soft core"

Application

- Surface hardened components and hard chrome plated workpieces
- Through hardened steels up to 65 HRC, Manganese high carbon steel

Advantages

- Hardened materials machined by cutting
- Good cutting rates and good surface quality
- Increased efficiency due to high blade-life

Features

- Optimised special geometry with negative rake angle
- Ground trapezoid tooth without set

Technical Data

Dimensions		Tooth pitch in ZpZ	
Width x thickness			
mm	Inch	3-4	2-3
27 x 0.90	1-1/16 x 0.035	TSN	
34 x 1.10	1-3/8 x 0.042	TSN	TSN
41 x 1.30	1-5/8 x 0.050	TSN	TSN
54 x 1.60	2-1/8 x 0.063		TSN
67 x 1.60	2-5/8 x 0.063		TSN
Contact length	[mm]	20-150	130-200
	[Inch]	0.8-5.9	5.1-7.9

TSN = Tooth shape TSN

UPGRADE: The new product generation of WIKUS' proven special band saw blade FUTURA[®] SN is available effective immediately. Tool lives up to twice as long can be achieved compared to the previous version thanks to its optimized tooth geometry in conjunction with the perfectly matched cutting material.

Materials Overview



- Case-hardening components

PROFIDUR[®]

The coated professional for profiles



- ⊕ Product level 3
- 📐 Trapezoid tooth
- Profiles
- ↕ Band width 54 x 1.3 - 67 x 1.6mm

Product Information



The coated professional for profiles

Applications

- Structurals and profiles
- Perfectly for industrial steel construction

Advantages

- Capacity increase by maximum cutting performance and blade-life
- Low-burr and precise cuts
- Considerable reduction of noise emission

Features

- Patented tooth geometry for interrupted cutting channel
- Sturdy carbide-tipped tooth edges coated with hard material

Technical Data

Dimensions		Tooth pitch in ZpZ	
Width x thickness			
mm	Inch	3-4	2-3
54 x 1.30	2-1/8 x 0.050		T
54 x 1.60	2-1/8 x 0.063	T	T
Contact length	[mm] [Inch]	90-150 3.5-5.9	150-270 5.9-10.6

T = Trapezoid tooth

Materials Overview



- Case-hardening steels, spring steels and ball-bearing steels
- Nitrided steel, high-speed steel and tool steel
- Construction, deep-drawn and machining steels
- Carbon steels, and quenched and tempered steels
- Cast iron

ARION[®] FG

The Royal Class of Band Sawing



- ▲ Product Level S
- ▭ Trapezoid tooth
- Solid materials
- ↕ Band width 54 x 1.1 - 100 x 1.1mm

Product Information



The Royal Class of Band Sawing

Discover the royal class of band sawing: with ARION[®] FG and its wear-resistant hard coating. With its carbide band saw blade, WIKUS has created a high-performance sawing tool that delivers maximum cutting power, shorter cutting times, and minimal cutting costs and material waste during the sawing process. Thanks to thin-cutting technology, users can benefit from maximum productivity and cost-effectiveness, especially when cutting steels.

Application Range

Application:

- Large series and mass cutting processes on high performance sawing machines
- Short piece production of solid materials, structural, case-hardened and tempering steels as well as cast iron
- Forging technology

Advantages:

- Extremely high cutting rate in continuous operation
- Significantly reduced cutting time and highest productivity
- Low material loss due to thin-cut technology and thereby savings in costs and production process
- Precise flatness of the cutting surfaces
- Excellent efficiency by high blade-life

Features:

- Carbide cutting edge with very wear-resistant grade
- Polished trapezoid tooth (FUTURA[®] geometry)
- Thin-cutting technology with very high blade stability
- Wear-resistant multi-layer hard coating on tooth edges and back edges

Technical Data

Technical Data

Dimensions		Tooth pitch in ZpZ					
Width x thickness							
mm	Inch	3-4	2-3	1.7-2	1.4-2	1-1.4	0.7-1
54 x 1.10	2-1/8 x 0.042	T	T	T	T		
67 x 1.10	2-5/8 x 0.042		T	T	T	T	
80 x 1.10	3-1/8 x 0.042				T	T	
100 x 1.10	4 x 0.042		T		T		T
Contact length	[mm]	90-150	130-250	200-300	250-500	500-800	800-2000
	[Inch]	3.5-5.9	5.1-9.8	7.9-11.8	9.8-19.7	19.7-31.5	31.5-78.7

T = Trapezoid tooth

Materials Overview



- Case-hardening steels, spring steels and ball-bearing steels
- Nitrided steel, high-speed steel and tool steel
- Construction, deep-drawn and machining steels
- Carbon steels, and quenched and tempered steels
- Cast iron

FUTURA[®] NE

The high-performance bestseller for non-ferrous metals

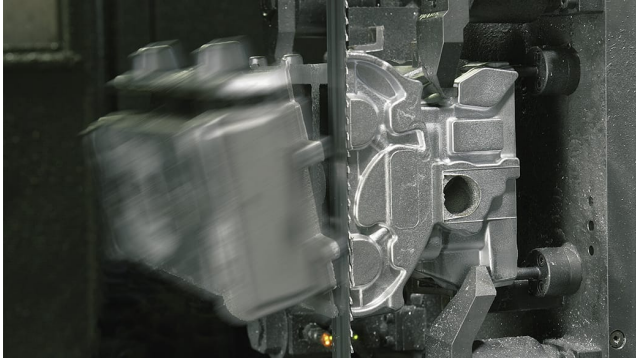

⊕ Product level 3

⊕ Trapezoid tooth

● Solid materials

Band width 27 x 0.9 - 80 x 1.6mm

⊕ Band width 1-1/16 x 0.035 - 3-1/8 x 0.063
Inch

Product Information



The high-performance bestseller for non-ferrous metals

Applications

- Aluminum mould and die castings, aluminum ingots and aluminum milling products
- Copper and copper alloys

Advantages

- Short clock rates and outstanding productivity due to high cutting performance
- Low material allowance by optimal surface quality
- Process reliability by high resistance against abrasion

Features

- Tooth edges made of specific carbide to prevent abrasion
- Ground trapezoid tooth with positive rake angle
- Optimal chip division for performance and surface quality

Technical Data (1/2)

Dimensions		Tooth pitch in ZpZ					
Width x thickness		variable					constant
mm	Inch	3-4	2-3	1.4-2	0.85-1.15	0.7-1	3
27 x 0.90	1-1/16 x 0.035	T					T
34 x 1.10	1-3/8 x 0.042	T	T	T			
41 x 1.30	1-5/8 x 0.050		T	T			
54 x 1.30	2-1/8 x 0.050			T			
54 x 1.60	2-1/8 x 0.063			T	T		
67 x 1.60	2-5/8 x 0.063			T			
80 x 1.60	3-1/8 x 0.063				T	T	
Contact length	[mm]	80-170	150-300	290-550	700-1400	900-2000	120-200
	[Inch]	3.1-6.7	5.9-11.8	11.4-21.6	27.6-55.1	35.4-78.7	4.7-7.9

T = Trapezoid tooth

Technical Data (2/2)

Dimensions		Tooth pitch in ZpZ
Width x thickness		constant
mm	Inch	2
27 x 0.90	1-1/16 x 0.035	
34 x 1.10	1-3/8 x 0.042	T
41 x 1.30	1-5/8 x 0.050	T
54 x 1.30	2-1/8 x 0.050	
54 x 1.60	2-1/8 x 0.063	
67 x 1.60	2-5/8 x 0.063	
80 x 1.60	3-1/8 x 0.063	
Contact length	[mm] [Inch]	200-400 7.9-15.7

T = Trapezoid tooth

Materials Overview



- Aluminium / aluminium alloys
- Non-ferrous metals

ECODUR®

The low-cost band saw blade for non-ferrous foundries

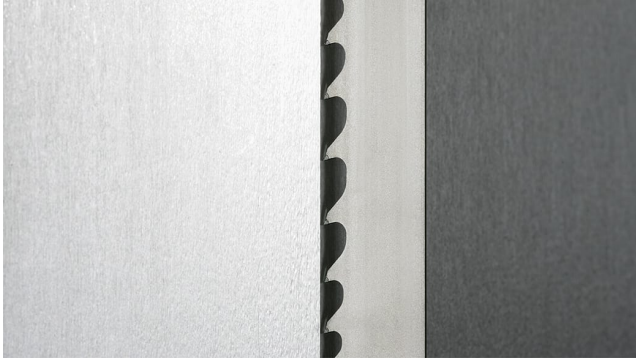

- ⊕ Product level 2
- 📐 Trapezoid tooth
- Solid materials
- ↕ Band width 13 x 0.8 - 54 x 1.6mm
Band width 1/2 x 0.032 - 2-1/8 x 0.063 Inch

Product Information



ECODUR® – The inexpensive band saw blade for non-ferrous foundries

Materials made of aluminum, copper and other non-ferrous metals as well as their alloys place excellent standards on machining. The processing of large quantities in foundries requires precise, often automated separation of risers and casting sprues.

In order to be able to economically machine castings in these applications, WIKUS has developed the ECODUR® band saw blade.

The band saw blade is equipped with tooth edges made of specific carbide, perfectly adapted to the requirements of non-ferrous metals and their alloys.

Thanks to the ground trapezoid tooth with positive rake angle, the carbide band saw blade cuts solid materials cleanly and quickly.

The short cutting times result in a noticeable increase in productivity. The high surface quality of the cut surfaces, which requires only minor post-processing, also contributes to this.

Application

- Cutting gates and risers on non-ferrous castings
- Aluminum and aluminum alloys as solid materials or profiles
- Copper and copper alloys as solid materials or profiles
- Aluminum round bars, blocks and precision plates

Advantages

- very good price-performance-ratio
- High productivity due to short cutting times
- Carbide cutting edge with high resistance to abrasive wear and thus high blade-life
- Good cutting surface for minimal finishing

Features

- Tooth edges made of specific carbide against abrasive wear

- Polished trapezoid tooth with positive rake angle and thus clean and fast separation of solid materials
- Patented chip division for high productivity and blade-life as well as good cutting surface quality

Technical Data

Dimensions		Tooth pitch in ZpZ				
Width x thickness		variable			constant	
mm	Inch	3-4	2-3	1.4-2	0.85-1.15	3
13 x 0.65	1/2 x 0.025					T
13 x 0.80	1/2 x 0.032	T				
20 x 0.80	3/4 x 0.035	T				
27 x 0.90	1-1/16 x 0.035	T	T			
34 x 1.10	1-3/8 x 0.042	T	T	T		
41 x 1.30	1-5/8 x 0.050	T	T	T		
54 x 1.30	2-1/8 x 0.050		T	T		
54 x 1.60	2-1/8 x 0.063		T	T	T	
67 x 1.60	2-5/8 x 0.063			T		
Contact length	[mm]	80-170	150-300	250-500	700-1400	120-200
	[Inch]	3.1-6.7	5.9-11.8	9.8-19.7	27.6-55.1	4.7-7.9

T = Trapezoid tooth

Materials Overview



- Aluminium / aluminium alloys
- Non-ferrous metals

TCTYRE[®]

The special band saw blade for rubber and metal composites



- ⚙ Product Level S
- 📐 Trapezoid tooth
- Tyres
- ↕ Band width 27 x 0.9 - 54 x 1.6mm

Product Information

TCTYRE[®] – The special band saw blade for rubber and metal composites

Composites of rubber and metal are mainly used as materials for vehicle tires and sheathed cables. WIKUS has developed the TCTYRE[®] carbide band saw blade especially for cutting such material combinations.

The TCTYRE[®] band saw blade provides reliable service in quality controls for the production of rubber composite items from car, truck, tractor, to large machine tires. The clean, straight cutting surfaces of the band saw blade excel in quality controls.

An additional field of application is the shredding and recycling of used tires and discarded cables. The shredding of scrap material is a prerequisite for recovering the metals it contains and positioning the rubber for further recycling.

Application

- for quality analysis of tires of all kinds

- For the economical comminution of rubber composite material

Advantages

- Very long lifetime and cutting rate even with larger than average tyres
- Vibration-resistant cut due to variable tooth pitch
- Very clean and good cutting surface for direct quality analysis

Features

- Carbide cutting edge with high wear resistance
- Optimized cutting edge geometry with variable tooth pitch for significantly reduced cutting force

Technical Data

Dimensions		Tooth pitch in ZpZ	
Width x thickness			
mm	Inch	3-4	2-3
27 x 0.90	1-1/16 x 0.035	T	T
34 x 1.10	1-3/8 x 0.042	T	T
41 x 1.30	1-5/8 x 0.050	T	T
54 x 1.30	2-1/8 x 0.050		T
54 x 1.60	2-1/8 x 0.063		T
Contact length	[mm]	90-150	150-270
	[Inch]	3.5-5.9	5.9-10.6

T = Trapezoid tooth

Materials Overview



- Tyres

TCT[®]

The band saw blade for mineral materials



- ▲ Product Level S
- 🔍 Standard- or Hooktooth
- Solid materials
- ↕ Band width 13 x 0.8 - 41 x 1.3mm

Product information

TCT[®] – The band saw blade for mineral materials

In some industry segments, such as construction, difficult materials or material combinations are often present for sawing. The TCT[®] meets the special requirements of the abrasive cutting material with very wear-resistant carbide saw teeth. In addition, the carbide band saw blade enables radius and contour cuts in certain dimensions, which are required for round designs.

TCT[®] was specially developed for cutting solid materials from mineral building materials. Normally, the materials have a rectangular cross-section, which can be perfectly processed with the band saw blade. The precisely cut construction elements with clean, straight cut edges, or desired contour cuts thus contribute to high productivity at the construction site.

Application

- Aerated concrete, graphite
- Insulation materials such as glass and rock wool
- Glass and carbon fibre reinforced plastic

Advantages

- Extremely resistant to abrasive wear
- high cutting performance
- Smaller cutting gap
- Usable without cooling lubricant

Features

- Carbide cutting edges with very high wear resistance
- Precisely set tooth geometry
- Constant tooth pitch for solid materials

Technical Data

Dimensions		Tooth pitch in ZpZ			
Width x thickness					
mm	Inch	4	3	2	1.25
13 x 0.80	1/2 x 0.032	S			
20 x 0.80	3/4 x 0.032	S	K		
27 x 0.90	1-1/16 x 0.035	S	K, S	K, S	
34 x 1.10	1-3/8 x 0.042		K, S	K	
41 x 1.30	1-5/8 x 0.050		K	K	K
Contact length	[mm]	80-120	120-200	200-400	300-800
	[Inch]	3.1-4.7	4.7-7.9	7.9-15.7	11.8-31.5

S = Standard tooth

K = Hook tooth

Materials Overview



- Hard-burnt coal, graphite
- Mineral building materials

DUROSET® PREMIUM

The sturdy all-round band saw blade coated with hard material

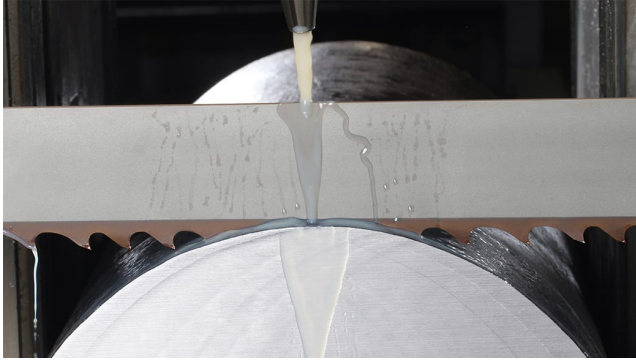

- ⊕ Product level 2
- 🪚 Hook tooth
- Solid materials
- ↕ Band width 34 x 1.1 - 80 x 1.6mm
Band width 1-3/8 x 0.042 - 3-1/8 x 0.063 Inch

Product Information

DUROSET® PREMIUM – The robust all-rounder band saw blade with hard coating

The DUROSET® PREMIUM owes its extreme robustness to the innovative, precision-ground cutting geometry in combination with a special limitation.

To reduce friction, the back edge of the DUROSET® PREMIUM is additionally provided with a hard coating. It offers even greater protection against wear.

Application

- All steels, forged and scaled surfaces
- Tempered materials with tensile strength greater than 1000N/mm²
- Aluminium bronze and cast iron
- Solid materials and thick-walled tubes and profiles
- Large block machining

Advantages

- Impressive increase in productivity

- Capacity potentials in bottlenecks
- Particularly high wear resistance and blade-life
- Low-vibration and smooth running due to variable tooth pitch
- High cutting rate for even shorter cutting times

Features

- Special hard coating for steel machining
- Additional back edge coating for lower friction
- Carbide tips in special geometry with positive rake angle for universal

Technical Data

Dimensions		Tooth pitch in ZpZ			
Width x thickness					
mm	Inch	1.8-2.5	1.4-1.8	1-1.4	0.7-1
34 x 1.10	1-3/8 x 0.042	K			
41 x 1.30	1-5/8 x 0.050	K			
54 x 1.60	2-1/8 x 0.063	K			
67 x 1.60	2-5/8 x 0.063		K	K	
80 x 1.60	3-1/8 x 0.063			K	K
Contact length	[mm]	180-350	300-700	500-1000	900-2000
	[Inch]	7.1-13.8	11.8-27.5	19.7-39.4	35.4-78.7

K = Hook tooth

Materials Overview



- Case-hardening steels, spring steels and ball-bearing steels
- Rust-proof and acid-resistant steels (ferretic)
- Nickel-based alloys
- Nitrided steel, high-speed steel and tool steel
- Titanium / titanium alloys
- Construction, deep-drawn and machining steels
- Carbon steels, and quenched and tempered steels
- Tempered steels (over 1000 N/mm² / 32 HRC)
- Rust-proof and acid-resistant steels (austenitic)
- Duplex and heat-resistant steels
- Cast iron
- Aluminium bronzes

TAURUS[®]

The inexpensive entry-level band saw blade with great features

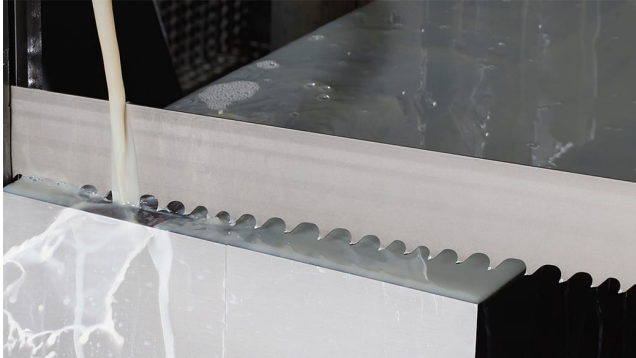

⊕ Product Level 1

⚙ Trapezoid tooth

● Solid materials

Band width 27 x 0.9 - 80 x 1.6mm

↕ Band width 1-1/16 x 0.035 - 3-1/8 x 0.063
Inch

Product Information



TAURUS[®] – The inexpensive entry-level band saw blade with great features

Superior quality - and a good price-performance ratio? That's TAURUS[®]!

A carbide band saw blade that is suitable for cutting solid materials from all steels and non-ferrous metals and can also be used for machines without a carbide package - A true all-rounder for materials that can no longer be sawn with bimetal.

TAURUS[®] is competitively priced, yet offers all the features you need for efficient sawing. The innovative tooth geometry and the proven carbide cutting material ensure good surface quality and minimize post-processing.

Application

- All steels and non-ferrous metals
- Solid material

Advantages

- Inexpensive carbide band saw blade with multiple uses
- Also for band saw machines without carbide package
- Productivity increase in the event of capacity bottlenecks
- Low post-processing due to good cut surface quality

Features

- Innovative tooth geometry
- Proven carbide cutting material
- High cutting rate due to trapezoid tooth with positive rake angle
- variable tooth pitch

Technical Data

Dimensions		Tooth pitch in ZpZ					
Width x thickness							
mm	Inch	3-4	2-3	1.7-2	1.4-2	1-1.4	0.7-1
27 x 0.90	1-1/16 x 0.035	T	T				
34 x 1.10	1-3/8 x 0.042	T	T				
41 x 1.30	1-5/8 x 0.050	T	T	T	T		
54 x 1.30	2-1/8 x 0.050	T	T	T	T		
54 x 1.60	2-1/8 x 0.063	T	T	T	T		
67 x 1.60	2-5/8 x 0.063			T	T	T	
80 x 1.60	3-1/8 x 0.063				T	T	T
Contact length	[mm]	80-170	150-300	250-370	290-550	500-1000	900-2000
	[Inch]	3.1-6.7	5.9-11.8	9.8-14.6	11.4-21.6	19.7-39.4	35.4-78.7

T = Trapezoid tooth

Materials Overview



- Case-hardening steels, spring steels and ball-bearing steels
- Rust-proof and acid-resistant steels (ferretic)
- Nickel-based alloys
- Nitrided steel, high-speed steel and tool steel
- Titanium / titanium alloys
- Construction, deep-drawn and machining steels
- Carbon steels, and quenched and tempered steels
- Tempered steels (over 1000 N/mm² / 32 HRC)
- Rust-proof and acid-resistant steels (austenitic)
- Duplex and heat-resistant steels
- Cast iron
- Aluminium / aluminium alloys
- Aluminium bronzes
- Non-ferrous metals

TAURUS® PREMIUM

The starter band saw blade coated with hard material



- ⊕ Product level 1
- 📐 Trapezoid tooth
- Solid materials
- ↕ Band width 34 x 1.1 - 67 x 1.6mm
Band width 1-3/8 x 0.042 - 2-5/8 x 0.063 Inch

Product Information



TAURUS® PREMIUM – The entry-level band saw blade with hard coating

The band saw blade TAURUS® PREMIUM is the economical solution for a broad application spectrum. The carbide band saw blade with hard coating is characterized by the possibility of an approx. 20% increase in cutting rate as well as a significant increase of blade-life.

The additional coating on the back edge of the strap ensures less friction. In addition, the band saw blade is ideal for new users in the carbide sector, as there is no need for a blade change when changing the material.

Application

- All steels
- Solid material
- aluminum alloys
- non-ferrous metals
- cast iron

Advantages

- High cutting performance and very good cutting surface
- Longlifetimereducesdowntime
- Low vibration and smooth running
- Ideal for beginners with high performance and service life requirements

Features

- Carbide-tipped tooth edges coated with hard material
- Additional back edge coating for lower friction
- Innovative tooth geometry
- High cutting rate due to trapezoid tooth with positive rake angle
- variable tooth pitch

Technical Data

Dimensions		Tooth pitch in ZpZ			
Width x thickness					
mm	Inch	3-4	2-3	1.7-2	1.4-2
34 x 1.10	1-3/8 x 0.042	T	T		
41 x 1.30	1-5/8 x 0.050	T	T	T	T
54 x 1.30	2-1/8 x 0.050		T	T	
54 x 1.60	2-1/8 x 0.063		T	T	T
67 x 1.60	2-5/8 x 0.063				T
Contact length	[mm]	80-170	150-300	250-370	290-550
	[Inch]	3.1-6.7	5.9-11.8	9.8-14.6	11.4-21.6

T = Trapezoid tooth

Materials Overview



- Case-hardening steels, spring steels and ball-bearing steels
- Rust-proof and acid-resistant steels (ferretic)
- Nickel-based alloys
- Nitrided steel, high-speed steel and tool steel
- Titanium / titanium alloys
- Construction, deep-drawn and machining steels
- Carbon steels, and quenched and tempered steels
- Tempered steels (over 1000 N/mm² / 32 HRC)
- Rust-proof and acid-resistant steels (austenitic)
- Duplex and heat-resistant steels
- Cast iron
- Aluminium / aluminium alloys
- Aluminium bronzes
- Non-ferrous metals

FUTURA[®] NE RS

The high-performance bestseller with reduced kerf loss for non-ferrous metals

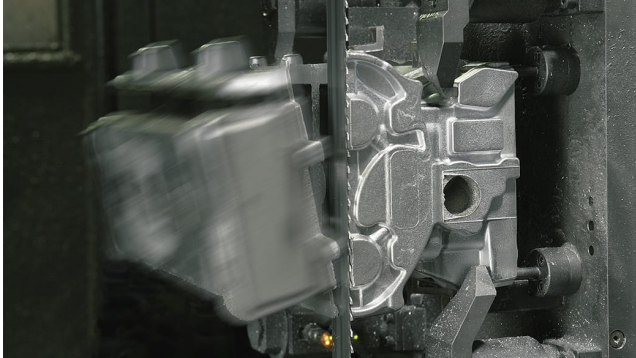

- ⊕ Product level 3
- ⚙ Trapezoid tooth
- Solid materials
- ↕ Band width 41 x 1.3 - 80 x 1.1mm

Product Information



The high-performance bestseller with reduced kerf loss for non-ferrous metals

Application

- Cutting of aluminum ingots, aluminum plate production

Advantages

- Extreme cutting performance by reduced cutting volume
- Optimised ingot output by reduced material loss
- Perfect cutting surface for lower finishing

Features

- Special grinding for reduced kerf width
- Ground trapezoid tooth with positive rake angle
- Optimal chip division for performance and surface quality

Technical Data

Dimensions		Tooth pitch in ZpZ			
Width x thickness					
mm	Inch	1.4-2	1-1.4	0.85-1.15	0.7-1
41 x 1.30	1-5/8 x 0.050	T			
54 x 1.10	2-1/8 x 0.042		T		
54 x 1.30	2-1/8 x 0.050	T			
54 x 1.60	2-1/8 x 0.063			T	T
80 x 1.10	3-1/8 x 0.042	T			
Contact length	[mm]	290-550	500-1000	700-1400	900-2000
	[Inch]	11.4-21.6	19.7-39.4	27.6-55.1	35.4-78.7

T = Trapezoid tooth

Materials Overview



- Aluminium / aluminium alloys
- Non-ferrous metals

FUTURA[®] PREMIUM SN

The specialist with hard material coating for hardest cases

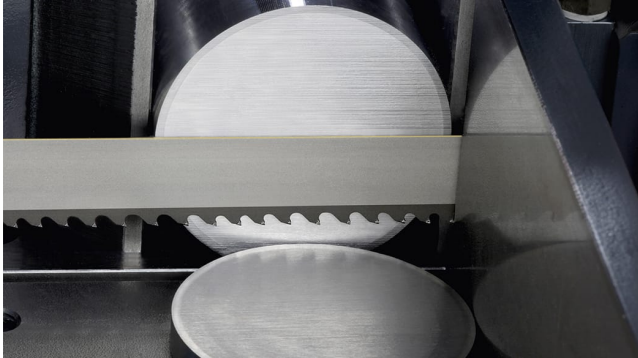

⊕ Product Level S

📐 Tooth shape TSN

● Solid materials

Band width 27 x 0.9 - 41 x 1.3mm

↕ Band width 1-1/16 x 0.035 - 1-5/8 x 0.050
Inch

Product Information



The specialist with hard material coating for hardest cases

Application

- Induction hardened and hard chrome plated workpieces
- Case-hardening steels up to 65 HRC, Manganese steel

Advantages

- Considerable increase of blade-life
- High cutting performance for efficiency increase
- Excellent surface quality

Features

- Carbide-tipped tooth edges coated with high-strength hard material
- Optimised special geometry with negative rake angle
- Extra back edge coating for lower friction

Technical Data

Dimensions		Tooth pitch in ZpZ
Width x thickness		
mm	Inch	3-4
27 x 0.90	1-1/16 x 0.035	TSN
34 x 1.10	1-3/8 x 0.042	TSN
41 x 1.30	1-5/8 x 0.050	TSN
Contact length	[mm]	20-150
	[Inch]	0.8-5.9

TSN = Tooth shape TSN

Materials Overview



- Case-hardening components

CUBOGRIT® S

The segmented CBN- coated band saw blade



- Ⓐ Product level 2
- ↕ Band width 10 x 0.5 - 100 x 1.1mm
Band width 3/8 x 0.020 - 4 x 0.042 Inch
- ⊙ Workpiece dimension medium
- ⚡ Segmented CBN-coating

Product Information



The segmented CBN-coated band saw blade

Application

- Hardened high speed steel (HSS), case-hardening steels
- High-alloy tool steels > 55 HRC
- Iron-based powder coatings, chilled casting, stellite
- Medium workpiece dimensions

Advantages

- High cutting performance
- Individual design of the coating geometry
- Low reworking due to very to good cutting surfaces

Features

- Segmented CBN-coating at the band edge
- Backing material made of alloyed tempering steel

CUBOGRIT® S is also available with a carrier band made of corrosion-resistant special steel as **CUBOGRIT® S VA**.

This execution offers the following advantages:

- Cooling with pure water
- No corrosion of backing material during longer downtime

In order to achieve an optimal and efficient result for your sawing applications, we will be gladly prepared to advise you on the possible combinations regarding the grain sizes, band saw blade dimensions as well as operating and basic conditions of CUBOGRIT®. Our experts of the technical customer care will gladly get in contact with you.

Machine requirements:

- Cutting speed higher than 1200 m/min
- High machine stability
- High torque of the drive engine

Technical Data (1/2)

Dimensions	
Width x thickness	
mm	Inch
10 x 0.50	3/8 x 0.020
13 x 0.65	1/2 x 0.025
16 x 0.50	5/8 x 0.020
20 x 0.50	3/4 x 0.020
20 x 0.80	3/4 x 0.032
27 x 0.50	1-1/16 x 0.020
27 x 0.70	1-1/16 x 0.028
27 x 0.90	1-1/16 x 0.035
34 x 1.10	1-3/8 x 0.042
41 x 0.50	1-5/8 x 0.020
41 x 0.80	1-5/8 x 0.032
41 x 1.30	1-5/8 x 0.050
50 x 0.90	2 x 0.035
67 x 0.70	2-5/8 x 0.028
80 x 0.90	3-1/8 x 0.035
80 x 1.10	3-1/8 x 0.042

Grain sizes: B91, B126, B252, B602

Alternative grain sizes and band dimensions upon request

Technical Data (2/2)

Dimensions	
Width x thickness	
mm	Inch
100 x 0.90	4 x 0.035
100 x 1.10	4 x 0.042

Grain sizes: B91, B126, B252, B602

Alternative grain sizes and band dimensions upon request

Materials Overview



- Hardened high speed steel (HSS), Case-hardening steels
- High-alloy tool steels > 55 HRC
- Iron-based powder coatings, chilled casting, stellite

CUBOGRIT® U

The CBN-coated band saw blade with tothing



- Ⓐ Product level 2
- ↕ Band width 10 x 0.5 - 100 x 1.1mm
Band width 3/8 x 0.020 - 4 x 0.042 Inch
- ⊙ Workpiece dimension large
- ⚡ Intermittent CBN-coating

Product Information



The CBN-coated band saw blade with tothing

Application

- Hardened high speed steel (HSS), case-hardening steels
- High-alloy tool steels > 55 HRC
- Iron-based powder coatings, chilled casting, stellite
- Large workpiece dimensions

Advantages

- Large chip space for material abrasion
- Individual design of the segment geometry (special tooth)
- Short cutting time due to high cutting performance

Features

- Raised segments with CBN-coating with variable pitch
- Backing material made of alloyed tempering steel

CUBOGRIT® U is also available with a carrier band made of corrosion-resistant special steel as **CUBOGRIT® U VA**. This execution offers the following advantages:

- Cooling with pure water
- No corrosion of backing material during longer downtime

In order to achieve an optimal and efficient result for your sawing applications, we will be gladly prepared to advise you on the possible combinations regarding the grain sizes, band saw blade dimensions as well as operating and basic conditions of CUBOGRIT®. Our experts of the technical customer care will gladly get in contact with you.

Machine requirements:

- Cutting speed higher than 1200 m/min
- High machine stability
- High torque of the drive engine

Technical Data (1/2)

Dimensions		Tooth pitch in ZpZ				
Width x thickness		variable			constant	
mm	Inch	30-30	20-20	12-12	8	6
10 x 0.50	3/8 x 0.020					T
13 x 0.50	1/2 x 0.020				T	
13 x 0.65	1/2 x 0.025				T	
16 x 0.50	5/8 x 0.020				T	
20 x 0.80	3/4 x 0.032				T	
27 x 0.50	1-1/16 x 0.020			T		
27 x 0.70	1-1/16 x 0.028	T		T		
27 x 0.90	1-1/16 x 0.035			T		
34 x 1.10	1-3/8 x 0.042		T			
41 x 0.50	1-5/8 x 0.020		T			
41 x 0.80	1-5/8 x 0.032		T			
41 x 1.30	1-5/8 x 0.050		T			
50 x 0.90	2 x 0.035		T			
54 x 1.10	2-1/8 x 0.042		T			
67 x 1.60	2-5/8 x 0.063	T				
80 x 1.10	3-1/8 x 0.042			T		

Grain sizes: B91, B126, B252, B602

Alternative grain sizes and band dimensions upon request

Technical Data (2/2)

Dimensions		Tooth pitch in ZpZ				
Width x thickness		variable			constant	
mm	Inch	30-30	20-20	12-12	8	6
100 x 0.90	4 x 0.035			T		
100 x 1.10	4 x 0.042	T		T		

Grain sizes: B91, B126, B252, B602

Alternative grain sizes and band dimensions upon request

Materials Overview



- Hardened high speed steel (HSS), Case-hardening steels
- High-alloy tool steels > 55 HRC
- Iron-based powder coatings, chilled casting, stellite

DIAGRIT[®] K

The continuously diamond coated band saw blade

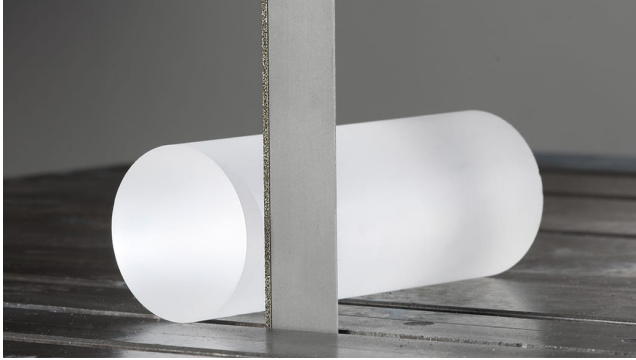

- ⊕ Product level 2
- ↕ Band width 10 x 0.5 - 100 x 1.1mm
Band width 3/8 x 0.020 - 4 x 0.042 Inch
- ⊙ Workpiece dimension small
- ◆ Continuous diamond coating

Product Information

The continuously diamond coated band saw blade

Application

- Glass, graphite, high-fired graphite, ceramic, silicon
- Concrete materials, carbon fibre reinforced plastic, sintered materials, virgin stone
- Small workpiece dimensions

Advantages

- No chipping on the contour edges
- Low finishing due to very good cutting surfaces

Features

- Continuous diamond coating on the band edge
- Backing material made of alloyed tempering steel

Technical Data (1/2)

Dimensions	
Width x thickness	
mm	Inch
10 x 0.50	3/8 x 0.020
13 x 0.50	1/2 x 0.020
13 x 0.65	1/2 x 0.025
16 x 0.50	5/8 x 0.020
20 x 0.50	3/4 x 0.020
20 x 0.80	3/4 x 0.032
27 x 0.50	1-1/16 x 0.020
27 x 0.70	1-1/16 x 0.028
27 x 0.90	1-1/16 x 0.035
34 x 1.10	1-3/8 x 0.042
41 x 0.50	1-5/8 x 0.020
41 x 0.80	1-5/8 x 0.032
41 x 1.30	1-5/8 x 0.050
50 x 0.90	2 x 0.035
54 x 1.10	2-1/8 x 0.042
67 x 0.70	2-5/8 x 0.028

Grain sizes: D64, D91, D126, D151, D181, D252, D301, D356, D426, D501, D601, D711

Alternative band dimensions upon request

Technical Data (2/2)

Dimensions	
Width x thickness	
mm	Inch
80 x 0.90	3-1/8 x 0.035
80 x 1.10	3-1/8 x 0.042
100 x 0.90	4 x 0.035
100 x 1.10	4 x 0.042

Grain sizes: D64, D91, D126, D151, D181, D252, D301, D356, D426, D501, D601, D711

Alternative band dimensions upon request

Materials Overview



- Silicon, glass, natural stone

DIAGRIT[®] S

The segmented diamond coated band saw blade



- Ⓐ Product level 2
- ⇕ Band width 10 x 0.5 - 100 x 1.1mm
Band width 3/8 x 0.020 - 4 x 0.042 Inch
- Ⓢ Workpiece dimension medium
- ◆ Segmented diamond coating

Product Information



The segmented diamond coated band saw blade

Application

- Glass, graphite, high-fired graphite, ceramic, silicon
- Concrete materials, carbon fibre reinforced plastic, sintered materials, virgin stone
- Medium workpiece dimensions

Advantages

- Higher cutting rate
- Individual coating geometry
- Low finishing thanks to good cutting surfaces

Features

- Segmented diamond coating on the band edge
- Backing material made of alloyed tempering steel

Technical Data (1/2)

Dimensions	
Width x thickness	
mm	Inch
10 x 0.50	3/8 x 0.020
13 x 0.65	1/2 x 0.025
16 x 0.50	5/8 x 0.020
20 x 0.50	3/4 x 0.020
20 x 0.80	3/4 x 0.032
27 x 0.50	1-1/16 x 0.020
27 x 0.70	1-1/16 x 0.028
27 x 0.90	1-1/16 x 0.035
34 x 1.10	1-3/8 x 0.042
41 x 0.50	1-5/8 x 0.020
41 x 0.80	1-5/8 x 0.032
41 x 1.30	1-5/8 x 0.050
50 x 0.90	2 x 0.035
67 x 0.70	2-5/8 x 0.028
80 x 0.90	3-1/8 x 0.035
80 x 1.10	3-1/8 x 0.042

Grain sizes: D64, D91, D126, D151, D181, D252, D301, D356, D426, D501, D601, D711

Alternative band dimensions upon request

Technical Data (2/2)

Dimensions	
Width x thickness	
mm	Inch
100 x 0.90	4 x 0.035
100 x 1.10	4 x 0.042

Grain sizes: D64, D91, D126, D151, D181, D252, D301, D356, D426, D501, D601, D711

Alternative band dimensions upon request

Materials Overview



- Silicon, glass, natural stone

DIAGRIT[®] U

The toothed diamond coated band saw blade



- Ⓐ Product level 2
- ⇕ Band width 10 x 0.5 - 100 x 1.1mm
Band width 3/8 x 0.020 - 4 x 0.042 Inch
- Ⓒ Workpiece dimension large
- ◆ Intermittent diamond coating

Product Information



The toothed diamond coated band saw blade

Application

- Glass, graphite, high-fired graphite, ceramic, silicon
- Concrete materials, carbon fibre reinforced plastic, sintered materials, virgin stone
- Large workpiece dimensions

Advantages

- Large gullet for material chipping
- Individual segment geometry (special tooth)
- Short cutting time due to excellent cutting rate

Features

- Protruding segments with diamond coating in different distances
- Backing material made of alloyed tempering steel

Technical Data (1/2)

Dimensions		Tooth pitch in ZpZ				
Width x thickness		variable			constant	
mm	Inch	30-30	20-20	12-12	8	6
10 x 0.50	3/8 x 0.020					x
13 x 0.50	1/2 x 0.020				x	
13 x 0.65	1/2 x 0.025				x	
16 x 0.50	5/8 x 0.020				x	
20 x 0.80	3/4 x 0.032				x	
27 x 0.50	1-1/16 x 0.020			x		
27 x 0.70	1-1/16 x 0.028	x		x		
27 x 0.90	1-1/16 x 0.035			x		
34 x 1.10	1-3/8 x 0.042		x			
41 x 0.50	1-5/8 x 0.020		x			
41 x 0.80	1-5/8 x 0.032		x			
41 x 1.30	1-5/8 x 0.050		x			
50 x 0.90	2 x 0.035		x			
54 x 1.10	2-1/8 x 0.042		x			
67 x 1.60	2-5/8 x 0.063	x				
80 x 1.10	3-1/8 x 0.042			x		

Grain sizes: D64, D91, D126, D151, D181, D252, D301, D356, D426, D501, D601, D711

Alternative band dimensions upon request

Technical Data (2/2)

Dimensions		Tooth pitch in ZpZ				
Width x thickness		variable			constant	
mm	Inch	30-30	20-20	12-12	8	6
100 x 0.90	4 x 0.035			x		
100 x 1.10	4 x 0.042	x		x		

Grain sizes: D64, D91, D126, D151, D181, D252, D301, D356, D426, D501, D601, D711

Alternative band dimensions upon request

Materials Overview



- Silicon, glass, natural stone

DIAGRIT[®] K VA

The continuously diamond coated band saw blade with stainless backing material

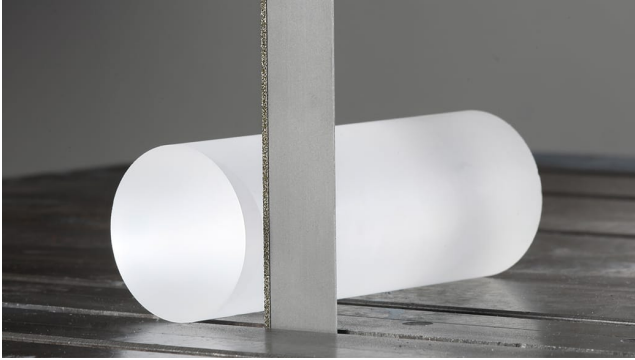

- ⚙ Product level 2
- ↕ Band width 13 x 0.5 - 100 x 1.1mm
Band width 1/2 x 0.020 - 4 x 0.042 Inch
- ⊙ Workpiece dimension small
- 💎 Continuous diamond coating

Product Information

The continuously diamond coated band saw blade with stainless backing material

Application

- Glass, graphite, high-fired graphite, ceramic, silicon
- Concrete materials, carbon fibre reinforced plastic, sintered materials, virgin stone
- Small workpiece dimensions

Advantages

- Oil-free cooling lubricant usable
- No corrosion of backing material during longer downtime
- No chipping on the contour edges
- Low finishing thanks to very good cutting surfaces

Features

- Continuous diamond coating on the band edge
- Backing material made of stainless special steel

Technical Data

Dimensions	
Width x thickness	
mm	Inch
13 x 0.50	1/2 x 0.020
20 x 0.50	3/4 x 0.020
20 x 0.80	3/4 x 0.032
27 x 0.50	1-1/16 x 0.020
41 x 0.50	1-5/8 x 0.020
41 x 0.80	1-5/3 x 0.032
54 x 0.50	2-1/8 x 0.020
60 x 0.50	2-1/3 x 0.020
80 x 1.10	3-1/8 x 0.042
100 x 1.10	4 x 0.042

Grain sizes: D64, D91, D126, D151, D181, D252, D301, D356, D426, D501, D601, D711

Alternative band dimensions upon request

Materials Overview



- Silicon, glass, natural stone

DIAGRIT[®] S VA

The segmented diamond coated band saw blade with stainless backing material



- Ⓐ Product level 2
- ⇕ Band width 13 x 0.5 - 100 x 1.1mm
Band width 1/2 x 0.020 - 4 x 0.042 Inch
- Ⓢ Workpiece dimension medium
- ⚡ Segmented diamond coating

Product Information



The segmented diamond coated band saw blade with stainless backing material

Application

- Glass, graphite, high-fired graphite, ceramic, silicon
- Concrete materials, carbon fibre reinforced plastic, sintered materials, virgin stone
- Medium workpiece dimensions

Advantages

- Oil-free cooling lubricant usable
- No corrosion of backing material during longer downtime
- Higher cutting rate
- Individual coating geometry

Features

- Segmented diamond coating on the band edge
- Backing material made of stainless special steel

Technical Data

Dimensions	
Width x thickness	
mm	Inch
13 x 0.50	1/2 x 0.020
20 x 0.50	3/4 x 0.020
27 x 0.50	1-1/16 x 0.020
41 x 0.50	1-5/8 x 0.020
41 x 0.80	1-5/8 x 0.032
60 x 0.50	2-1/3 x 0.020
80 x 1.10	3-1/8 x 0.042
100 x 1.10	4 x 0.042

Grain sizes: D64, D91, D126, D151, D181, D252, D301, D356, D426, D501, D601, D711

Alternative band dimensions upon request

Materials Overview



- Silicon, glass, natural stone

DIAGRIT[®] U VA

The toothed diamond coated band saw blade with stainless backing material

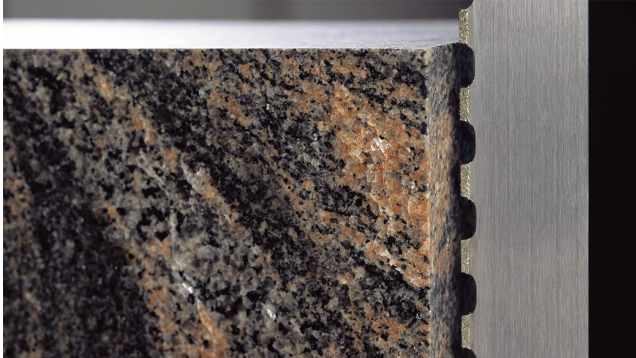

- Ⓐ Product level 2
- ↕ Band width 20 x 0.5 - 100 x 1.1mm
Band width 3/4 x 0.020 - 4 x 0.042 Inch
- ⊙ Workpiece dimension large
- ◆ Intermittent diamond coating

Product Information



The toothed diamond coated band saw blade with stainless backing material

Application

- Large workpiece dimensions
- Concrete materials, carbon fibre reinforced plastic, sintered materials, virgin stone
- Glass, graphite, high-fired graphite, ceramic, silicon

Advantages

- Oil-free cooling lubricant usable
- No corrosion of backing material during longer downtime
- Large gullet for material chipping
- Short cutting time due to excellent cutting rate

Features

- Protruding segments with diamond coating in different distances
- Backing material made of stainless special steel

Technical Data

Dimensions		Tooth pitch in ZpZ			
Width x thickness		variable			constant
mm	Inch	30-30	20-20	12-12	8
20 x 0.50	3/4 x 0.020				x
41 x 0.50	1-5/8 x 0.020		x		
41 x 0.80	1-5/8 x 0.032		x		
80 x 1.10	3-1/8 x 0.042	x		x	
100 x 1.10	4 x 0.042	x		x	

Grain sizes: D64, D91, D126, D151, D181, D252, D301, D356, D426, D501, D601, D711

Alternative band dimensions upon request

Materials Overview



- Silicon, glass, natural stone

TCGRIT[®] K

The carbide coated saw band with continuous coating



- ⬆ Product Level 2
- Solid materials and profiles
- ↕ Band width 6 x 0.5 - 32 x 1.1mm
Band width 1/4 x 0.020 - 1-1/4 x 0.042 Inch
- ⊖ Workpiece dimension small

Product Information

The carbide coated saw band with continuous coating

Application:

- cables and wires, composite materials, metal flex hoses
- glass fibre and carbon fibre reinforced plastics (GRP / CRP)
- small workpiece dimensions

Advantages:

- long life due to high wear resistance
- low rework due to high surface quality

Features:

- continuously carbide coated
- extremely durable band edge, suitable for wet and dry cutting

Technical Data

Dimensions		Grain sizes		
Width x thickness				
mm	Inch	525	301	181
6 x 0.50	1/4 x 0.020		X	
10 x 0.65	3/8 x 0.025		X	
13 x 0.50	1/2 x 0.020		X	
13 x 0.65	1/2 x 0.250		X	X
20 x 0.80	3/4 x 0.032		X	
25 x 0.90	1-1/16 x 0.035	X		
32 x 1.10	1-1/4 x 0.042	X		

Materials Overview



- Silicon, glass, natural stone
- Glass fibre
- Cables and wires
- Metal flex hoses

TCGRIT[®] U

The carbide coated saw band with discontinuous coating



- ⚙ Product Level 2
- Solid materials and profiles
- ↕ Band width 10 x 0.65 - 38 x 1.1mm
Band width 3/8 x 0.025 - 1-1/2 x 0.042 Inch
- ⊕ Workpiece dimension large

Product Information



The carbide coated saw band with discontinuous coating

Application:

- glass fibre and carbon fibre reinforced plastics (GRP / CRP)
- abrasive construction materials, case-hardened steel, two-wheeler and car tyre
- larger workpiece dimensions

Advantages:

- long life due to high wear resistance
- low rework due to high surface quality

Features:

- discontinuous carbide coating
- extremely durable band edge, suitable for wet and dry cutting

Technical Data

Dimensions		Grain sizes		
Width x thickness				
mm	Inch	525	356	301
10 x 0.65	3/8 x 0.025			X
13 x 0.65	1/2 x 0.025			X
20 x 0.80	3/4 x 0.320			X
25 x 0.90	1 x 0.035	X	X	
32 x 1.10	1-1/4 x 0.042	X		
38 x 1.10	1-1/2 x 0.042	X		

Materials Overview



- Silicon, glass, natural stone
- Glass fibre
- Cables and wires
- Metal flex hoses

CUBOGRIT[®] K

The continuously CBN-coated band saw blade

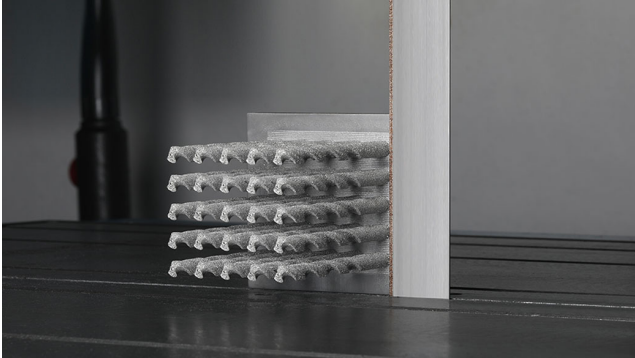

- Ⓐ Product level 2
- ↕ Band width 10 x 0.5 - 100 x 1.1mm
Band width 3/8 x 0.020 - 4 x 0.042 Inch
- ⊙ Workpiece dimension small
- ⚡ Continuous CBN-coating

Product Information



The CBN-coated band saw blade

WIKUS expands its portfolio of the coated band saw blades by the new product CUBOGRIT[®] which uses cubic boron nitride (CBN) as cutting material. Cubic boron nitride is the second hardest material known. Besides a high hardness and strength, also thermal and chemical resistance are its properties. Due to these properties, CUBOGRIT[®] band saw blades are ideal for the reliable processing of hardened ferrous materials and hard alloys as well as for hard alloys produced in 3D-print. From now on, even the hardest alloys up to 70 HRC can be cut economically with CUBOGRIT[®].

Application

- hardened high speed steel (HSS), case-hardened steels
- high-alloy tool steels > 55 HRC
- iron-based powder coatings, chilled casting, stellite
- small workpiece dimensions

Advantages

- no chipping at the edge of the contours
- low reworking due to very good cutting surfaces

Features

- complete CBN-coating at the band edge
- backing material made of alloyed tempering steel

CUBOGRIT[®] K is also available with a backing material made of corrosion-resistant special steel as **CUBOGRIT[®] K VA**.

This execution offers the following advantages:

- cooling with pure water
- no corrosion of backing material during longer downtime

Machine requirements:

- cutting speed higher than 1200 m/min
- high machine stability
- high torque of the drive engine

Technical Data (1/2)

Dimensions	
Width x thickness	
mm	Inch
10 x 0.50	3/8 x 0.020
13 x 0.50	1/2 x 0.020
13 x 0.65	1/2 x 0.025
16 x 0.50	5/8 x 0.020
20 x 0.50	3/4 x 0.020
20 x 0.80	3/4 x 0.032
27 x 0.50	1-1/16 x 0.020
27 x 0.70	1-1/16 x 0.028
27 x 0.90	1-1/16 x 0.035
34 x 1.10	1-3/8 x 0.042
41 x 0.50	1-5/8 x 0.020
41 x 0.80	1-5/8 x 0.032
41 x 1.30	1-5/8 x 0.050
50 x 0.90	2 x 0.035
54 x 1.10	2-1/8 x 0.042
67 x 0.70	2-5/8 x 0.028

Grain sizes: B91, B126, B252, B602

Alternative band grain sizes and dimensions upon request

Technical Data (2/2)

Dimensions	
Width x thickness	
mm	Inch
80 x 0.90	3-1/8 x 0.035
80 x 1.10	3-1/8 x 0.042
100 x 0.90	4 x 0.035
100 x 1.10	4 x 0.042

Grain sizes: B91, B126, B252, B602

Alternative band grain sizes and dimensions upon request

Materials Overview





- Hardened high speed steel (HSS), Case-hardening steels
- High-alloy tool steels > 55 HRC
- Iron-based powder coatings, chilled casting, stellite

KREOS[®]

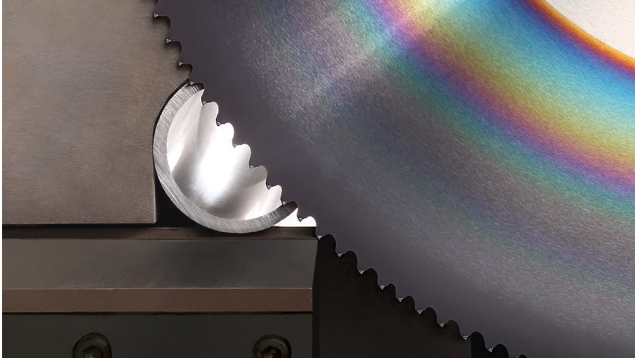
The high-performance circular saw blade with variable tooth pitch for steel pipes and profiles



-  innovative tooth geometry for the interrupted cutting channel
-  variable tooth pitch
-  steels with low carbon levels < 1.5 %

Product information



KREOS[®] sets standards for processing thin-walled pipes and profiles with small cross-sections and is highly suitable for cutting applications in mass cut production processes as well.

The innovative specific chip space geometry with small variable tooth pitches based on the WIKUS joint technology lend *KREOS*[®] properties that are unique in the market.

KREOS[®] stands out to its excellent cutting performance that is up to 40% higher than competitive products, making it THE all-round efficient productive solution.

The high-performance circular saw blade with variable tooth pitch for steel pipes and profiles

Things are really moving at WIKUS. WIKUS demonstrates all its technological and innovative prowess in this new, completely in Spangenberg developed high-tech circular saw blade *KREOS*[®].

Your advantages at a glance



reduction of cutting costs
thanks to reproducible high cutting performance



higher productivity
thanks to small variable tooth pitches with carbide tips



excellent cutting surface quality
thanks to optimal tip geometry



less saw blade changes and machine downtimes
thanks to a significant increase of blade-life



reduction of sawing noise
thanks to smooth operation with variable tooth pitches

- high-performance circular sawing systems in mass cutting processes

Features

- innovative tooth geometry for the interrupted cutting channel
- variable tooth pitch
- carbide tipped with hard material coating

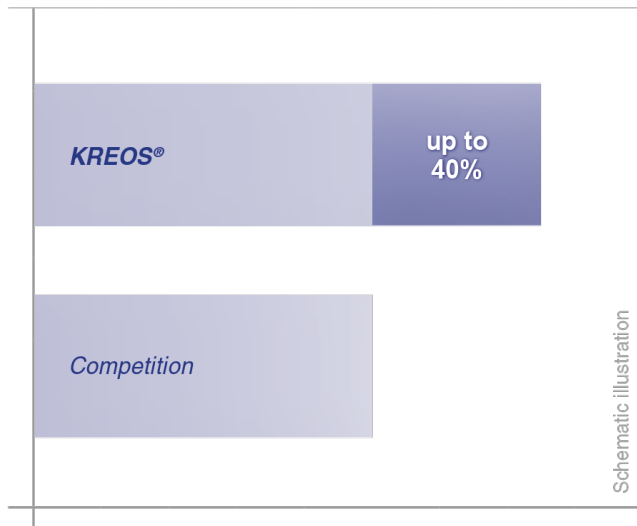
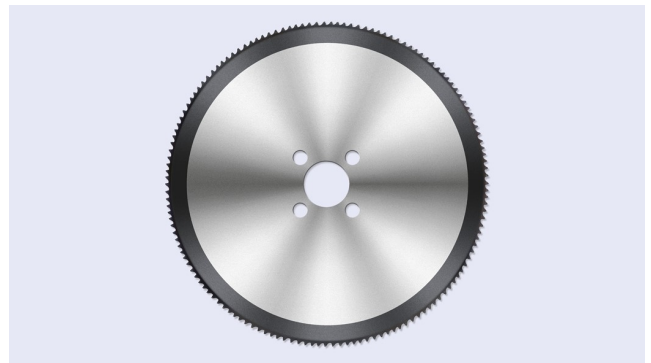

Increase of cutting performance

Application Range

Applications

- thin-walled pipes and profiles
- steels with low carbon levels < 1.5 %, tensile strength up to 1200 N/mm²
- single and multiple cutting

Customer information

Due to an updated coating process, all WIKUS precision circular saw blades will be successively changed to a modified optical appearance. All technical properties, product advantages as well as the usual WIKUS quality remain unchanged.

Technical Data (1/2)

(D)	(S1)	(S2)	(d)	Teeth (T)	Pin holes	
mm	mm	mm	mm	variable	4	2
285,00	2,00	1,75	40,00	84v	4/12/64	
285,00	2,00	1,75	32,00	144v	4/9/50 4/11/63	
285,00	2,50	2,25	40,00	84v	4/12/64	
315,00	2,50	2,25	40,00	66v	4/12/64	
315,00	2,50	2,25	32,00	84v	4/9/50	
315,00	2,50	2,25	32,00	132v	4/9/50	
315,00	2,50	2,25	40,00	132v	4/11/63	
315,00	2,50	2,25	40,00	132v	4/12/64	
315,00	2,50	2,25	50,00	132v	4/16/80	
315,00	2,50	2,25	32,00	168v	4/9/50	
315,00	2,50	2,25	40,00	168v	4/12/64	2/8/55
350,00	2,50	2,25	32,00	144v	4/12/64	
350,00	2,50	2,25	50,00	144v	4/16/80	
350,00	2,50	2,25	50,00	192v	4/16/80	
350,00	2,70	2,50	50,00	120v	4/16/80	
350,00	2,70	2,50	32,00	144v	4/12/64	

Technical Data (2/2)

(D)	(S1)	(S2)	(d)	Teeth (T)	Pin holes	
mm	mm	mm	mm	variable	4	2
350,00	2,70	2,50	50,00	144v	4/16/80	
350,00	2,70	2,50	50,00	168v	4/16/80	
360,00	2,50	2,25	50,00	102v	4/16/80	
400,00	2,70	2,50	50,00	192v	4/16/80	

Materials Overview





- Case-hardening steels, spring steels and ball-bearing steels
- Nitrided steel, high-speed steel and tool steel
- Construction, deep-drawn and machining steels
- Carbon steels, and quenched and tempered steels
- Rust-proof and acid-resistant steels

MIRUS[®]

High-performance circular saw blade for rust- and acid-resistant pipes and profiles



-  innovative tooth geometry for the interrupted cutting channel
-  variable tooth pitch
-  rust- and acid-resistant materials

Product information







mance, innovative solution for processing thin-walled pipes and profiles in rust- and acid-resistant materials.

MIRUS[®] optimises your sawing process with a new cutting geometry, a small variable tooth pitch and a unique number of carbide tipped teeth. *MIRUS*[®] is in a class of its own in the market with respect to productivity, cost savings and surface quality.

High-performance circular saw blade for rust- and acid-resistant pipes and profiles

WIKUS has rounded off its product range with the addition of the newly, completely in Spangenberg developed high-performance circular saw blade *MIRUS*[®]. In proven WIKUS quality, *MIRUS*[®] is a high-perfor-

Your advantages at a glance

- 
reduction of tool costs
thanks to reproducible high cutting performance
- 
increase of productivity
thanks to small variable tooth pitches with carbide tips
- 
reduction of saw blades change
thanks to more blade life
- 
good cutting surface
thanks to precise cutting geometry
- 
less finishing
thanks to low-burr cutting

- variable tooth pitch
- carbide cutting materials and coatings

Customer information

Due to an updated coating process, all WIKUS precision circular saw blades will be successively changed to a modified optical appearance. All technical properties, product advantages as well as the usual WIKUS quality remain unchanged.

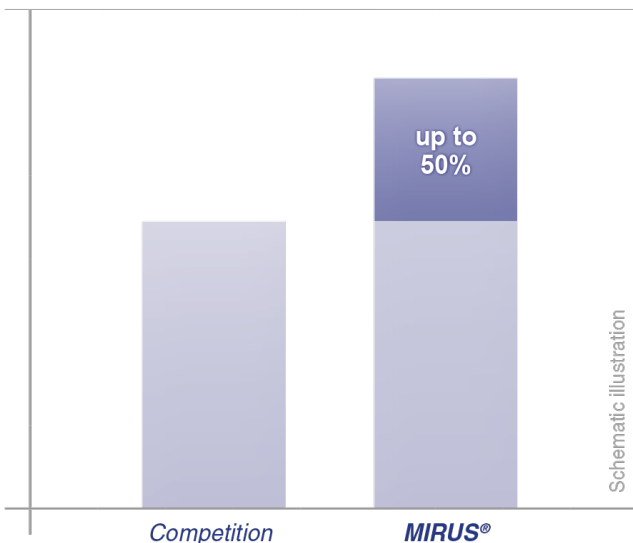

Increase of productivity

Application Range

Applications

- thin-walled pipes and profiles
- high-performance circular sawing systems in mass cutting processes
- rust- and acid-resistant materials
- single and multiple cutting

Features

- specially designed cutting geometry

Technical Data

(D)	(S1)	(S2)	(d)	Teeth (T)	Pin holes	
mm	mm	mm	mm	variable	4	2
285,00	2,00	1,75	32,00	174v	4/9/50	
285,00	2,00	1,75	40,00	174v	4/12/64	
315,00	2,50	2,25	32,00	132v	4/9/50	
315,00	2,50	2,25	40,00	132v	4/12/64	
315,00	2,50	2,25	32,00	168v	4/12/64	
315,00	2,50	2,25	40,00	168v	4/12/64	2/8/55
350,00	2,50	2,25	40,00	168v	4/12/64	2/8/55
350,00	2,50	2,25	40,00	192v	4/12/64	2/8/55
350,00	2,70	2,50	50,00	168v	4/16/80	
350,00	2,70	2,50	50,00	192v	4/16/80	
400,00	2,70	2,50	40,00	192v	4/12/64	2/8/55
400,00	2,70	2,50	50,00	192v	4/16/80	

Materials Overview



- Case-hardening steels, spring steels and ball-bearing steels
- Nitrided steel, high-speed steel and tool steel
- Construction, deep-drawn and machining steels
- Carbon steels, and quenched and tempered steels
- Aluminium / aluminium alloys
- Non-ferrous metals
- Rust-proof and acid-resistant steels



TRIVAX⁷®

MÁQUINAS • FERRAMENTAS • EQUIPAMENTOS

R. Diva Pecorari Buldrini, 187 - Piracicaba/SP
(19) 3433-1118 | vendas@trivax.com.br | trivax.com.br